

SCHAEFER JIB FURLING

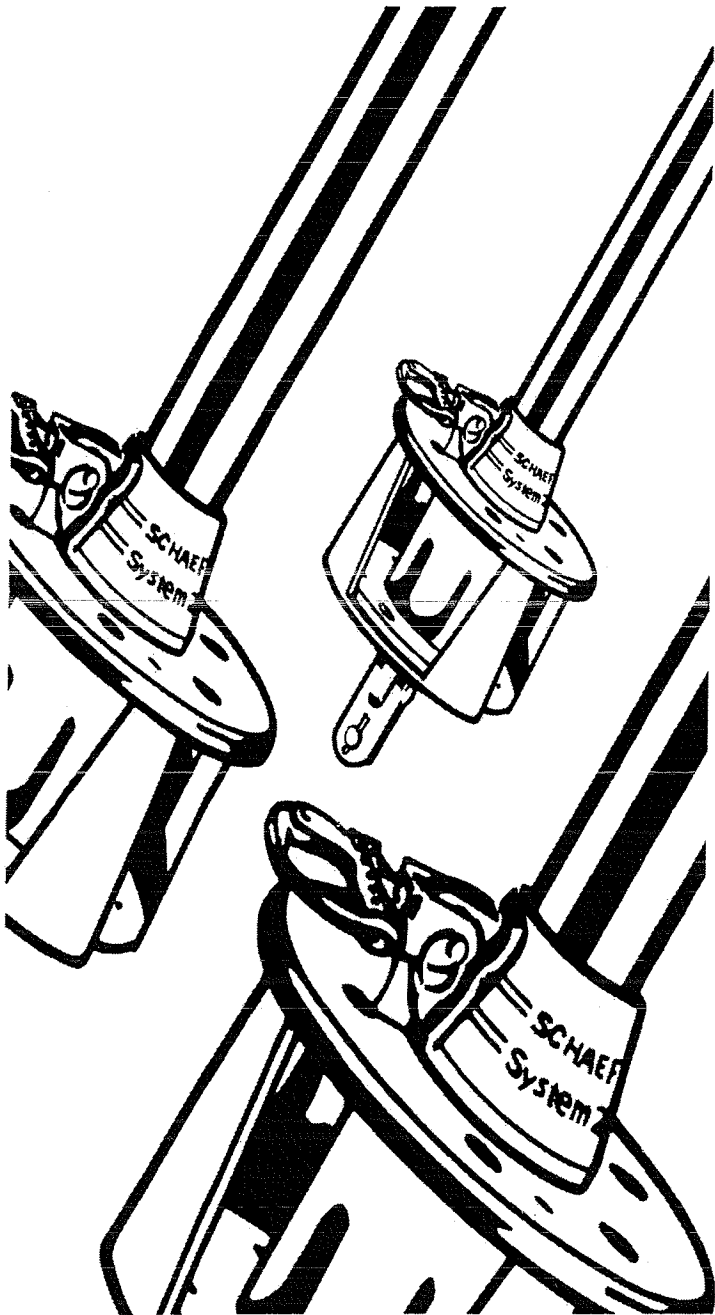

Installation Instructions

Systems

1100

2100

3100

SCHAEFER LEGENDARY STRENGTH

Schaefer Marine, Inc.
158 Duchaine Boulevard
New Bedford, MA 02745-1293

TEL: 508/ 995-9511
FAX: 508/ 995-4882
Email: sales@schaefermarine.com
www.schaefermarine.com

Introduction

Thank you for purchasing this Schaefer Furling/ Reefing System. When designing this system, our first goal was to build a strong, rugged and durable furler to make sailing safer and more enjoyable.

Our second goal was to make the Schaefer furler a logical and simple design, to allow easy installation over your existing 1x19 wire, rod or pre-cut dealer headstay.

Strength is just the beginning of why a Schaefer furler is the best system available. From years of research, we've developed a combination of features that rival any furler, at any price. That's because we've designed in, and improved, all the useful features of the world's best rated furlers, and eliminated the ideas that just didn't make sense.

If any of the assembly steps are unclear to you, please feel free to contact us for assistance.

Good Sailing!

Table of Contents

Introduction	2
Pre-Installation Notes	3-4
Existing Headstay Installation	5-12
Pre-cut Headstay Installation	14-19
Operation (For All Systems)	21-24
Appendices	25-32
Inspection/ Maintenance	25
Parts Listing	26-28
Technical Specs/ Sailmaker Instructions	29
New Headstay/ Foil Cutting Instructions	30-31
Warranty	32

Standard Components

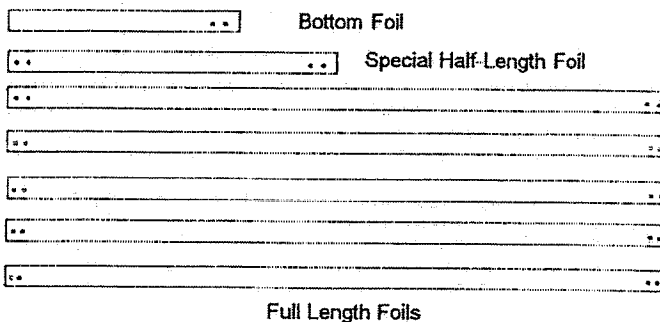
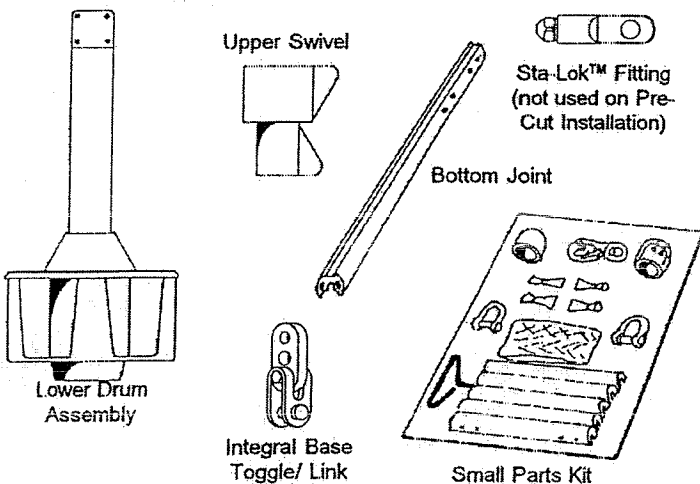

Required Tools

Tools:

- (1) Needle nose pliers
- (1) Wire cutters*
**(not used on pre-cut installation)*
- (1) Hacksaw
- (1) Rivet gun
(1/8" nose 11-2100/5/32", 3100)
- (1) Flat head screwdriver -med.
- (1) Phillips screwdriver -med.
- (2) Crescent wrenches -med.
**(not used on pre-cut installation)*
- (1) Measuring tape
- (1) Roll of rigging tape
- (1) Short length of light line
- (1) Large Plastic Bucket

Application:

- To remove cotter pins
- To cut the headstay.*
- To cut the foils to length.
- To join the foils and joints.
- To adjust fasteners in lower drum.
- To install Sta-Lok™ fitting.*
- Miscellaneous measurements.
- Wire cuts and rigging.
- To support foils.
- To contain small parts.



Note

All Schaefer furlers are assembled with thread sealing compound to protect the fasteners from corrosion and to help prevent loosening.

Use caution when handling any fasteners, as this compound may be a skin or eye irritant. Wash hands thoroughly after disassembly.

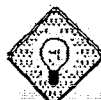

Note

The services of a professional yacht rigger could end up saving you time and money should you improperly install the furler or encounter an unusual rigging problem.

Pre-Installation Notes

The installation of the furler may require someone to go aloft in a Bosun's chair to remove the headstay prior to assembly, and to re-attach the headstay after assembly. If you are uneasy going aloft in a Bosun's chair or with any other aspect of the furler assembly procedure, please seek the assistance of a professional yacht rigger.

If you are assembling the system on an existing or new headstay, please check the following items to insure that your installation will go smoothly.

If you are assembling on a pre-cut headstay (dealer or OEM), it has been pre-screened for installation problems.



Going Aloft

DO NOT treat the job of going up the mast lightly. Use a safety line or a second halyard to back up the halyard being used.

Use a heavy-duty Bosun's chair in good condition which provides good support and security. Large, deep tool pockets are helpful.

Never attach a snap shackle directly to the Bosun's chair. Bypass the snap shackle and use a "D" shackle or tie the chair to the halyard.

Never allow anyone to stand under the person working aloft. Any tool or pin dropped from the top of the mast could be a lethal weapon.



Electrical Hazards/Mast Support

DO NOT bring in contact with electrical cables/ high tension lines.

The furling system is manufactured from aluminum extrusions which are highly conductive. Serious injury or death could result from shocks induced from contact with powerlines.

DO NOT assemble and install in unstable weather conditions where lightning is present or eminent. Lightning striking a mast is likely to travel down the system. Contact with the system could be fatal.

DO NOT assemble with the headstay attached to the boat. The system is designed to be assembled on the ground. You will require dock space the length of your headstay. In addition, there should be adequate clearance from neighboring boats to allow the finished furler to be hoisted back up to the masthead.

Make sure the mast is supported before removing the headstay. DO NOT use a snap shackle halyard to support the mast. Lash or use a "D" shackle attached to a substantial deck fitting. Deck stepped masts are at particular risk of falling, if not fitted with a temporary headstay. Secure a line to the top of the headstay in order to prevent it from dropping on deck when the masthead pin is released.

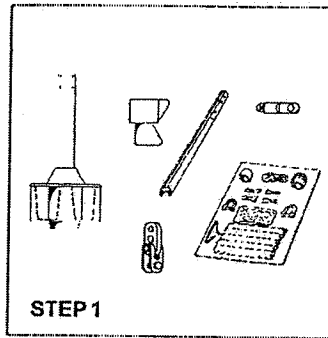

STEP 1
Unpack the furler and check the pieces against the provided parts listing.

We suggest that you place all small parts and tools in buckets to avoid losing them overboard. If your dock or workspace is rough, wrap the components with tape and cardboard to prevent scratches.

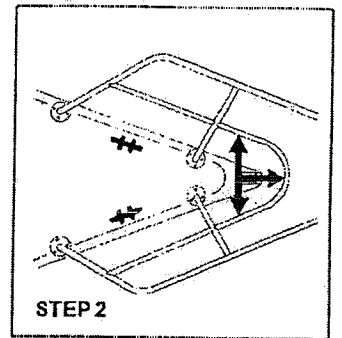

STEP 2
Check to make sure there is adequate clearance for the drum from the bow pulpit, anchor roller and other hardware mounted on the bow.

Confirm that the wire and rigging pin sizes are the same as the parts supplied in the kit.

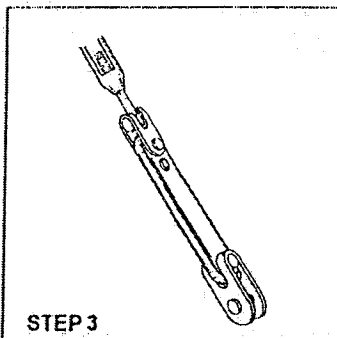

STEP 3
It may be necessary to install a LONG INTEGRAL TOGGLE/ LINK at the bottom of the system in order to raise the drum above any obstructions.

Please reference the Schaefer Marine catalog for complete specifications on this optional LONG/ INTEGRAL TOGGLE/ LINK.

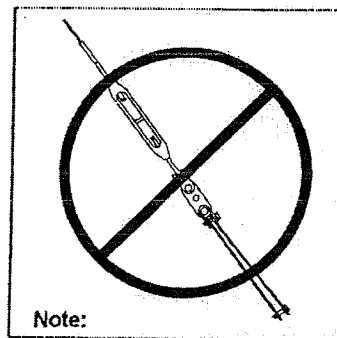

Note:
DO NOT use dual link tangs attached to the end of the toggle.

There is a risk of failure if you use this configuration without a toggle at the stemhead fitting.

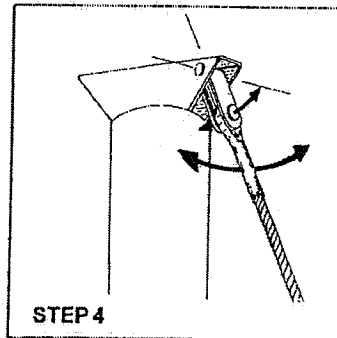

STEP 4
Inspect the connection of the headstay at the masthead.

There must be a toggle at the masthead to allow a "universal" motion of the headstay!

Schaefer's Integral Toggle/ Link will provide universal motion at the base of the system.

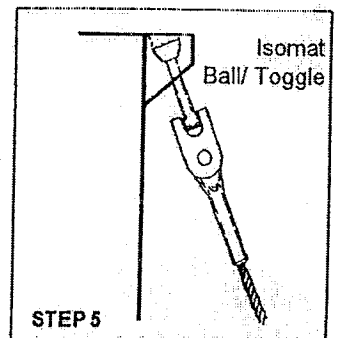

STEP 5
Spars manufactured by Isomat that do not have a separate masthead ball/toggle fitting MUST have the headstay modified to include this fitting.

Failure to provide the headstay with a proper toggle could result in eventual failure of the wire end fittings and loss of the mast!

Important Note: Two Different Installations!



WARNING

In order to provide an easily assembled system for both installation on existing or pre-cut headstays, we have divided this manual into two different installation methods.

Special instructional supplements pertaining to OEM systems are provided with each furling system.

There are two installation methods for installing Schaefer furling Systems. Choose the appropriate method for your application and follow the installation steps for that method contained in this manual.

Wherever possible, parts have been pre-cut and pre-drilled in our factory, to assure a very high level of quality and an easier installation for you

We suggest that you read the following instructions several times, prior to assembly, to familiarize yourself with the names of the components and each procedure. We also suggest a "trial run" practice assembly prior to the final assembly and riveting of the product.

Existing Headstay Installation (Top-Down) is for most common owner or rigger retrofitting to existing 1x19 wire or rod headstays.

Method 1



Go To
Pg. 5

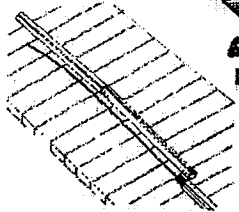

Existing Headstay

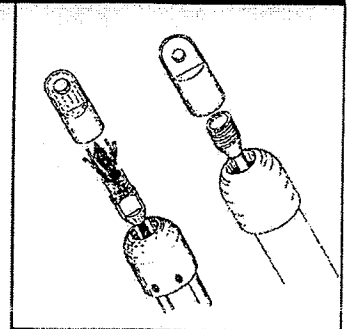
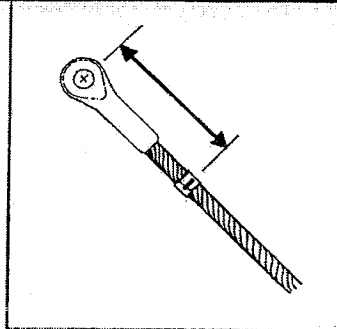
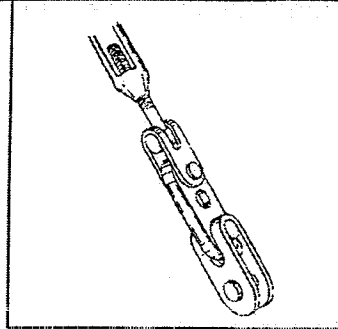

In the Existing Headstay Installation (Top-Down), the total length of your 1x19 stainless wire headstay or rod is shortened at the top to compensate for the addition of a special Integral Toggle/ Link added to the base of the System.

We provide the heavy-duty base toggle/link that allows proper articulation to absorb side loads that otherwise might fatigue a conventional turnbuckle stud. Your turnbuckle is attached to the base toggle/link providing full adjustability

The top cap, foils and drum unit are assembled "top-down" over the top of your existing headstay.

As the headstay is lengthened by the addition of the new base toggle/link, you must remove an equal amount of wire to adjust for the new length.

With the system assembled over the headstay, a provided Sta-Lok™, or custom rod fitting is installed in place of the old swage stud and the total length is returned to your original pin-pin measurement.

Pre-cut Headstay Installation (Bottom-Up) is for new boats with a dealer installed system, or boats requiring a new swaged headstay.

Method 2



Go To
Pg. 14

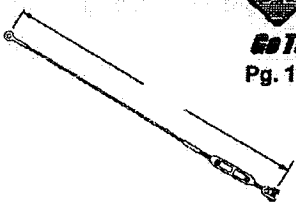

Pre-cut Headstay

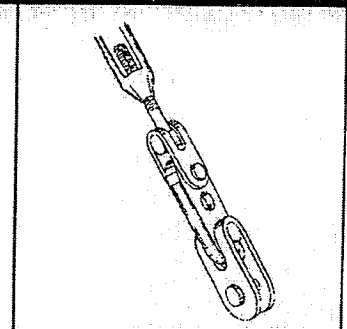
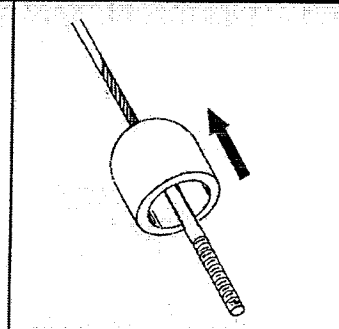
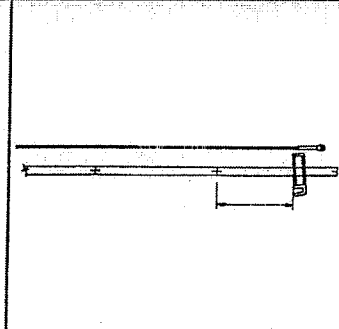

The Pre-cut Installation (Bottom-Up) is designed for Dealer/ OEM installed systems with pre-determined headstay lengths and foils that have been marked or pre-cut at Schaefer.

You will not utilize a Sta-Lok™ fitting because a new headstay (with eye fitting, and screw stud on bottom) has been cut to length for use with this Schaefer System

This installation may also be used for boats requiring a new headstay.

Special instructions have been provided to determine the proper headstay and upper foil length for use with the system.

Starting with the headstay off the boat and the turnbuckle removed from the swage stud:

The top cap, foils and drum unit are assembled "bottom-up" over the threaded turnbuckle swage stud and up the wire to the swage eye at the top of the wire.

We provide the heavy-duty base toggle/link that allows proper articulation to absorb side loads that otherwise might fatigue a conventional turnbuckle stud

Your turnbuckle is attached to the base toggle/link providing full adjustability

Existing Headstay Installation

Used for most common owner or rigger retrofitting to existing 1x19 stainless wire or rod headstays.

In the Existing Headstay Installation (Top-Down), the total length of your 1x19 stainless steel wire headstay is shortened at the top to compensate for the addition of a special Integral Toggle/Link added to the base of the System. A provided Sta-Lok™ fitting is installed in place of the old swage stud returning your pin/pin measurement to its original length.



WARNING

Do Not use this method for a Pre-cut Headstay Installation used for Dealer/ OEM installed systems.

Go To Pg. 14 For complete Pre-cut Headstay Installation instructions for new boats with a dealer installed furling system or for boats fitted with a new headstay.

Same Installation for Rod Headstays!

The installation procedure for rod headstays is essentially the same as for wire headstays. The step-by-step procedure listed in these instructions apply to rod headstays.

Conversion will require the rod to be shortened and re-headed to compensate for the length of the base toggle/link.

The primary difference is that you will shorten the rod at the top and utilize a new two-piece eye fitting instead of the Sta-Lok™ fitting described in these instructions. The rod headstay cannot be cut on the dock and reheaded without special equipment. Coil the headstay and take it to a rigger who has a heading machine for rod.

The two piece eye fitting is composed of a lower portion, or NOSE and an upper portion, or EYE. The NOSE will be fitted onto the rod prior to heading. The NOSE and reheaded rod then will pass through the FOILS.

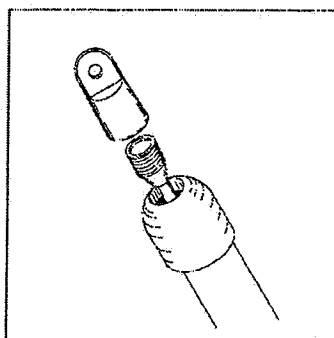

Note

Rod headstays are typically modified and assembled by a professional yacht rigger requiring special equipment.

When the furling system is fully assembled over the rod, the EYE will be threaded onto the NOSE to complete the headstay.

Be sure to secure the fitting with permanent thread locking fluid.

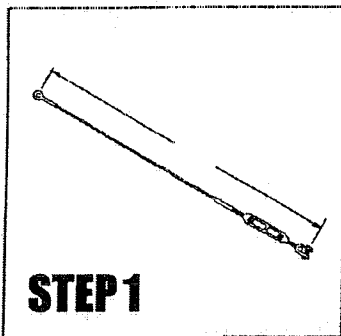

STEP 1

Lay the headstay out on the dock or work area. Inspect for wear, fraying or damage.

If you are unsure of the condition of your headstay, please seek the advice of a professional yacht rigger.

Measure your existing headstay length pin to pin for your records.

Be sure to note the turnbuckle position. (half open, open, closed)

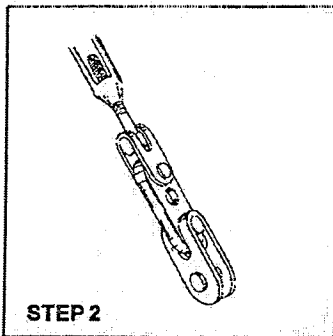

STEP 2

Add the INTEGRAL TOGGLE/LINK to the bottom end of the headstay turnbuckle.

Close the turnbuckle (tighten) at this time.

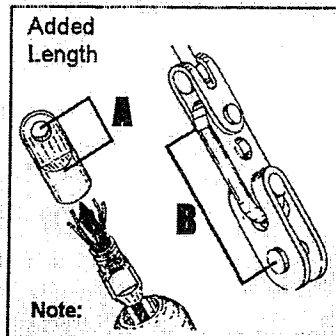

Added Length

Note:

It is necessary to compensate for the additional length of the **STANDARD** INTEGRAL TOGGLE/LINK and the eye portion of the Sta-Lok™ fitting that will be added to your headstay.

The combined length (toggle & Sta-Lok™) to be removed (see step 3) from your headstay for a standard Schaefer installation are as follows:

System	A + B
1100	5 3/8" (137mm)
2100	6 1/8" (155mm)
3100	7 5/8" (194mm)

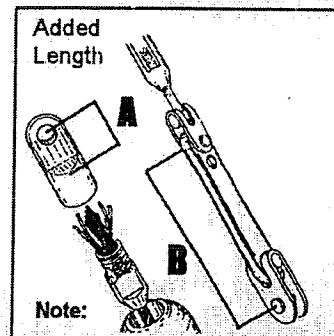

Added Length

Note:

If Schaefer **LONG** INTEGRAL TOGGLE/ LINKS are used, remove the following total amount of wire:

The combined length (toggle & Sta-Lok™) to be removed (see step 3) from your headstay for a Long Schaefer installation are as follows:

System	A + B
1100	12 3/8" (314mm)
2100	13 5/8" (346mm)
3100	16 5/8" (422mm)



WARNING

If masthead or other toggles are added, an additional amount of wire should be removed!

Use the following deductions and calculation to determine the proper amount of wire to remove.

Use these deductions only if you have a custom application

Schaefer Integral Toggle Deductions (pin/pin)

System	Standard
1100	4 1/8" (105mm)
2100	4 5/8" (118mm)
3100	6" (152mm)

System	Long
1100	10 1/8" (257mm)
2100	12 1/8" (309mm)
3100	15" (382mm)

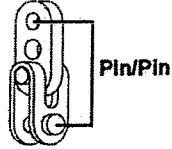

Schaefer Sta-Lok™ Deductions

Wire Size	Deduction
3/16" (5mm)	System 1100
7/32" (6mm)	1 1/4" (32mm)
1/4" (7mm)	
9/32" (8mm)	System 2100
5/16" (8mm)	1 1/2" (38mm)
3/8" (11mm)	System 3100
7/16" (12mm)	1 3/4" (44mm)

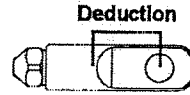

Custom Calculation

Schaefer Integral Toggle Link Deduction

+

Sta-Lok™ or Eye Deduction

+

Additional Toggle or Fitting Deduction

Total Wire Cut Length

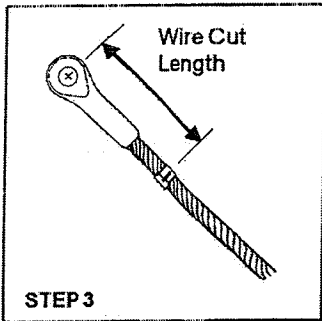

Measure down the appropriate length from the center of the hole in the old wire fitting or swage stud at the top of the wire.

Wrap tape around the wire and make a mark with a pencil or pen.

Cut the wire at this mark.

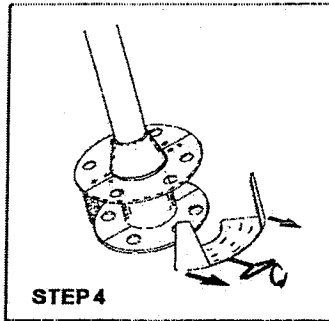

Loosen the captive screws on the STAINLESS CAGES and remove them from the LOWER DRUM AND TORQUE TUBE ASSEMBLY.

These two screws are captivated in the collars and only need to be loosened for removal of the cages.

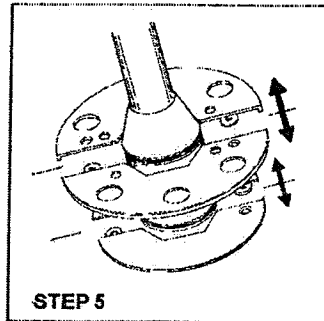

Remove the TOP and BOTTOM PLATES from the DRUM ASSEMBLY.

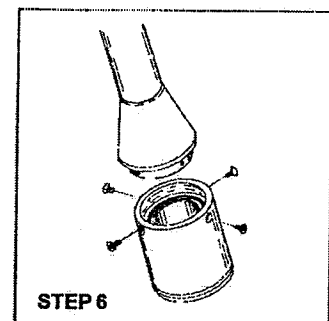

Remove the flat head fasteners in the side of the LOWER DRUM, releasing the TORQUE TUBE.

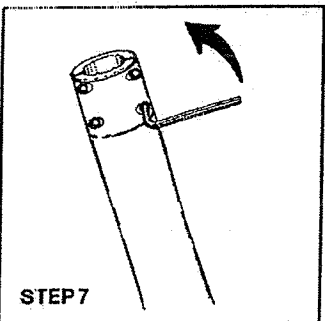

Loosen the four captive, Allen head fasteners in the top of the TORQUE TUBE.

The screws are captivated in the clamp and only need to be loosened.

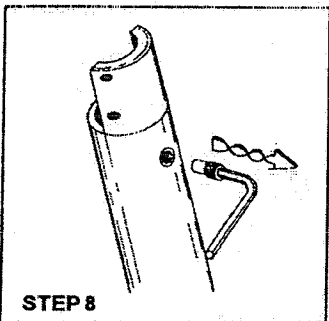

Remove the STOP PIN from the side of the TORQUE TUBE.

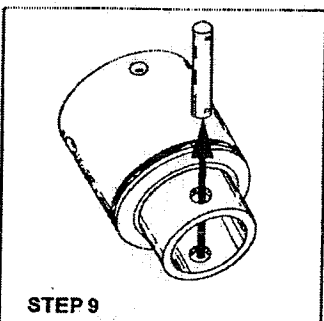

Remove the stainless BASE PIN from the LOWER SWIVEL.

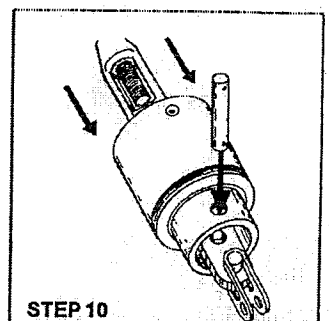

Slide the LOWER SWIVEL over the top (cut end) of the wire and down to the INTEGRAL TOGGLE/LINK.

Replace the BASE PIN thru the LOWER SWIVEL and the hole provided in the middle of the INTEGRAL TOGGLE/LINK.

Replace COTTER PINS in the BASE PIN. Split the COTTER PINS to prevent them from falling out, but do not bend them over as this might make it difficult to replace the STAINLESS CAGES.

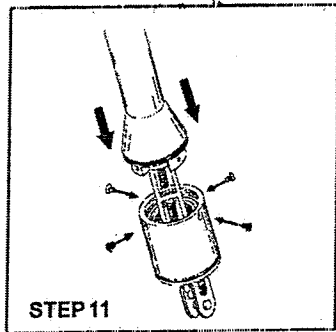

STEP 11

Slide the TORQUE TUBE over the top end of the wire, slide down and fasten temporarily to the LOWER SWIVEL.

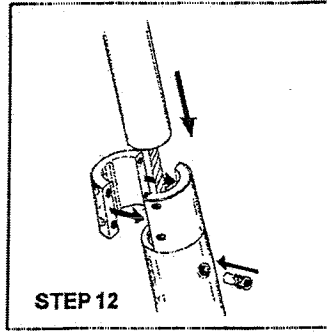

STEP 12

Replace the STOP PIN in the TORQUE TUBE to the point of being flush with the outside of the tube.

Slide the BOTTOM FOIL (drilled holes up) down the wire into the TORQUE TUBE until it reaches the STOP PIN.

Tighten the four captive fasteners in the CLAMP.

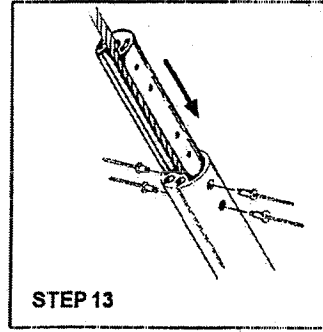

STEP 13

Insert the BOTTOM JOINT into the top of the BOTTOM FOIL.

The BOTTOM JOINT has drilled holes located near its top end that should be aligned with the holes in the BOTTOM FOIL.

Fit all rivets into their holes prior to riveting, then rivet in place.

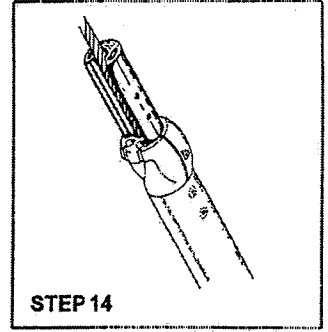

STEP 14

Add the stainless SAIL FEEDER. The SAIL FEEDER should clamp tightly to the BOTTOM JOINT and abut the top of the BOTTOM FOIL.

Make certain the feeder is installed as shown in the illustration.

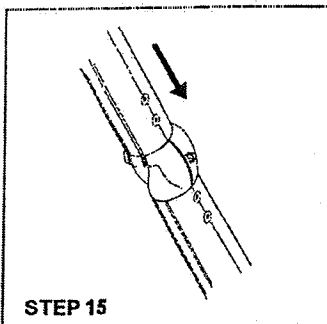

STEP 15

Add a STANDARD FOIL over the top of the wire and slide down to butt against the top of the SAIL FEEDER.

Fit all rivets into their holes and then rivet in place.

Make certain rivet heads are flush.

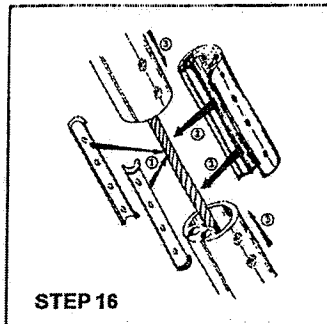

STEP 16

Continue to assemble STANDARD FOILS and JOINTS.

These JOINTS will use two piece liners which should be placed onto the wire and then snapped into the JOINT with the round side of the liners facing the inside of the JOINT.

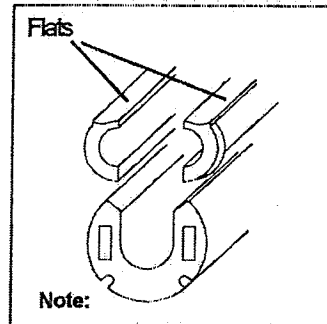

Flats

Note:

Be sure the liner flat sides are on the same side.

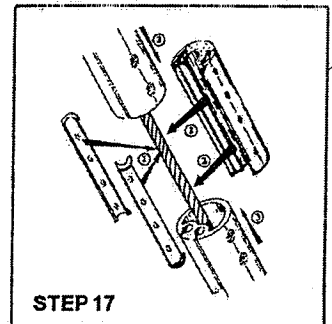

STEP 17

Slide the FOILS over the JOINTS riveting each together as you go until you are approximately 8' (2.4m) from the top end of the wire.

Make sure to fit all the rivets into their holes prior to riveting.

Do not cut or rivet these last FOILS until you read and understand steps 18, 19 and 20

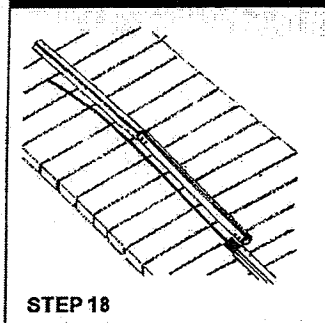

STEP 18

Lay the last two FOILS alongside the wire in preparation for measurement and cutting.

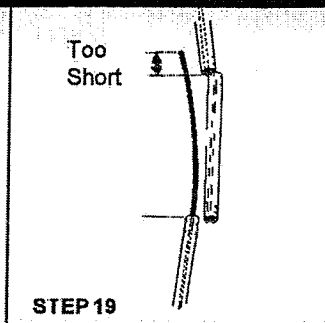

STEP 19

The TOP JOINT will be installed in the TOP FOIL in Step 21.

It is important that the TOP FOIL be at least 18" long when cut in order to accommodate both the length of the STANDARD JOINT and the TOP JOINT.

The turnbuckle must be closed at this time.

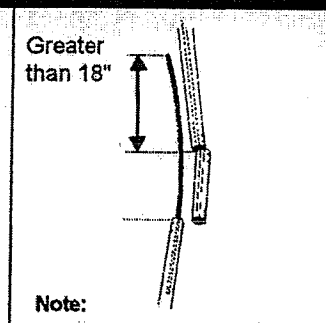

Note:

If needed, a pre-drilled HALF LENGTH FOIL has been provided to be used in place of the second from the top FULL LENGTH FOIL, thus making the TOP FOIL long enough to accept the TOP JOINT.

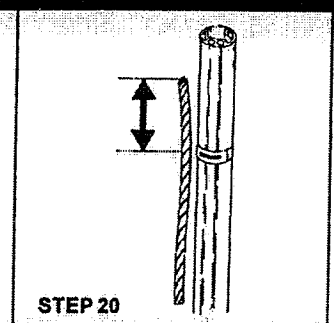

STEP 20

Lay the last (uppermost) FOIL alongside the wire and mark from the end of the wire.

Be sure turnbuckle is fully closed before marking.

System 1100	2"
System 2100	2"
System 3100	3"

Assure that the last FOIL will be no less than 18" and cut the FOIL with a hacksaw.

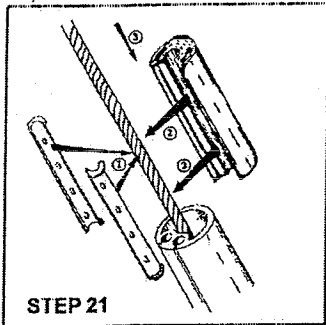

STEP 21

Insert the TOP JOINT with liners into the top of the last FOIL.

The TOP JOINT has a welded "nub" on the upper end to prevent it from sliding down the TOP FOIL.

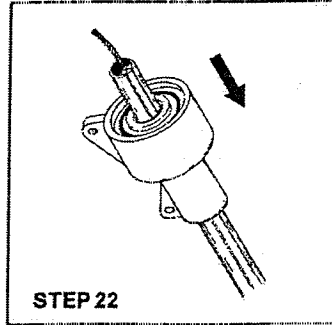

STEP 22

Install the UPPER SWIVEL over the top of the system and slide down to the FEEDER.

Make sure that the swivel slides freely over all riveted connections.

Make sure the large portion is up!

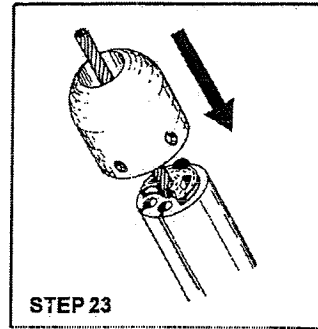

STEP 23

Add the TOP CAP to the TOP FOIL and tighten the set screws.

Align one of the two set screws in the TOP CAP with one of the two sail grooves and tighten both screws with the Allen wrench provided in the kit.

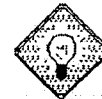

Congratulations!

The FOILS are now complete and the next procedure is the disassembly and installation of the DRUM/TORQUE TUBE portion of the system.

We suggest that all loose parts be kept in buckets or boxes and that parts be tied or taped to prevent them from falling overboard during final assembly.

Opening the turnbuckle will increase the length of the system and allow the complete unit to be more easily fit onto the boat later in the assembly.

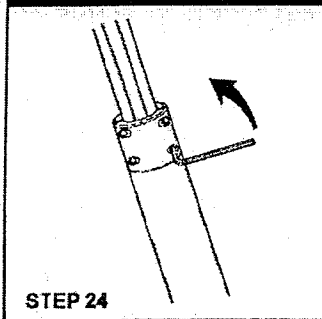

STEP 24

Loosen the fasteners in the CLAMP

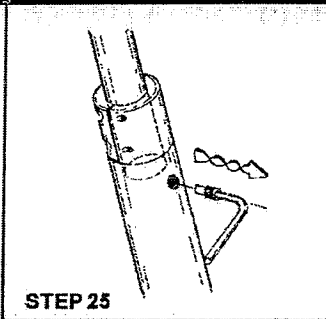

STEP 25

Remove the STOP PIN from the TORQUE TUBE.

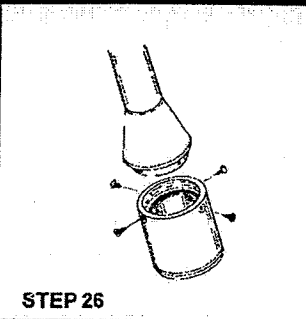

STEP 26

Remove the fasteners securing the TORQUE TUBE to the LOWER SWIVEL.

Slide the TORQUE TUBE up to expose the turnbuckle.

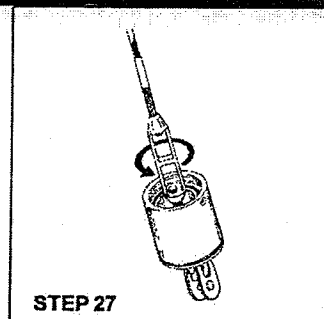

STEP 27

Open the turnbuckle as much as possible and replace the cotter pins.

The pins should be secure but do not bend them over at this time.

Opening the turnbuckle will also expose more wire from the top foil to facilitate installation of the Sta-Lok™ Fitting.

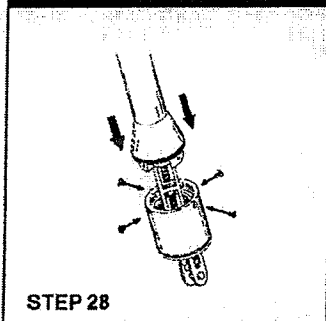

STEP 28

Re-fasten the TORQUE TUBE to the LOWER SWIVEL.

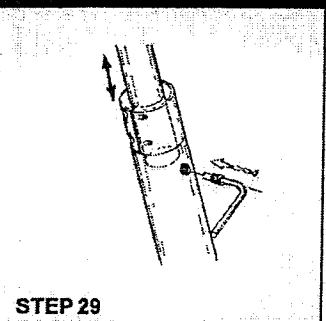

STEP 29

Adjust the FOILS until the STOP PIN can be reinstalled in the TORQUE TUBE.

The BOTTOM FOIL should rest on top of the STOP PIN.

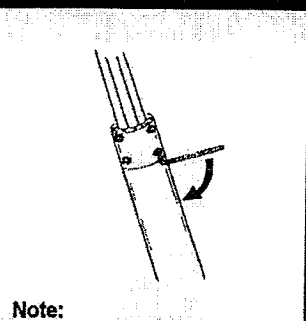

Note:

Tighten the four fasteners on the CLAMP.

You will need to remove the fasteners one more time when the furler is installed on the boat.

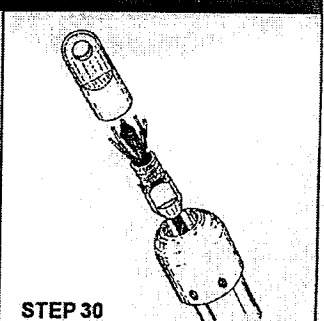

STEP 30

Install the STA-LOK® wire fitting following the STA-LOK® instructions.

Use permanent thread locking fluid on this fitting.



Congratulations!

The furler is now partially assembled and ready to be installed on the boat.

In preparation for hauling the system aloft:

Slide the UPPER SWIVEL down the FOILS until it rests on top of the SAIL FEEDER. Tape or tie in place.

If the UPPER SWIVEL is not positioned in this manner, there is a risk that it will slide down in an uncontrolled manner when the system is being raised to the masthead, causing injury to you or your assistants.

If the UPPER SWIVEL binds on any of the JOINTS, the rivet heads should be checked to assure they are flush.



WARNING

Do not try to lift the system from or with the Bosun's chair.

Use a second halyard to adjust the system into position and replace the rigging pin at the masthead.

Once the masthead pin is in place, swing the drum unit into position and pin at the stemhead.

Make sure upper and lower cotter pins are properly bent.

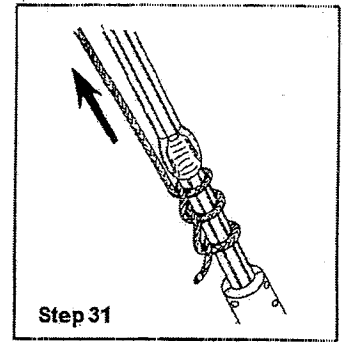

Step 31

Once the system is fitted to the boat, you must adjust your turnbuckle one final time to tune your rig.

Support the FOILS with the jib halyard by tying a series of half hitches below the FEEDER, then take up the slack on the halyard.

Steps 32-35 should be familiar to you. These steps describe turnbuckle access described earlier.

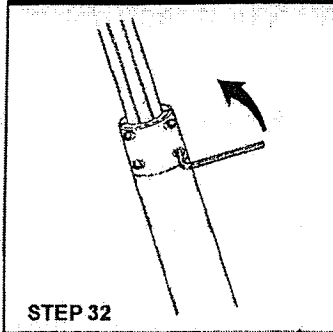

STEP 32

Loosen the four captive fasteners in the CLAMP.

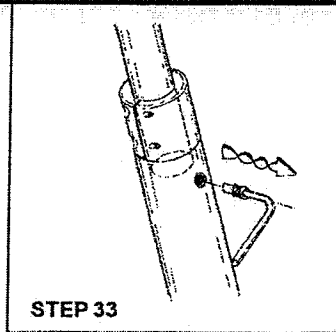

STEP 33

Remove the STOP PIN from the front of the TORQUE TUBE

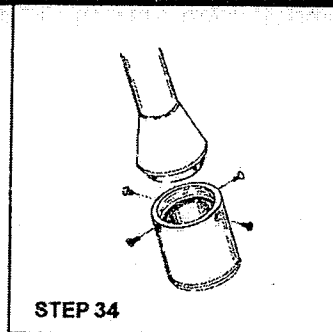

STEP 34

Remove the four fasteners holding the TORQUE TUBE to the LOWER SWIVEL.

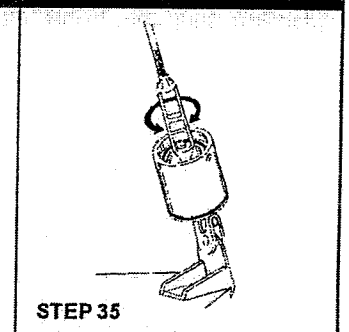

STEP 35

Slide the TORQUE TUBE up to reveal the turnbuckle.

Adjust the turnbuckle as required to tighten the headstay and tune the rig.

Replace and set the cotter pins to prevent the turnbuckle from unthreading.

Steps 36-39 should also be familiar. These steps describe re-assembly of the drum unit.

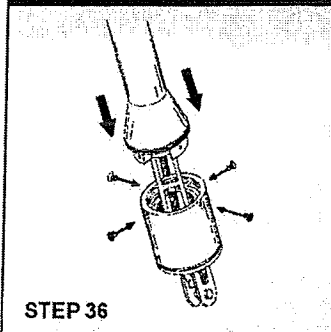

STEP 36

Lower the TORQUE TUBE back down onto the LOWER SWIVEL and replace the fasteners.

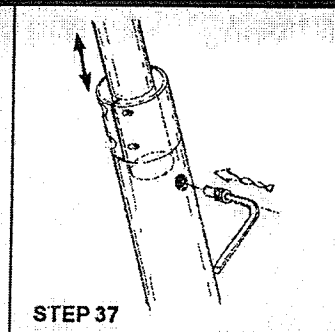

STEP 37

Adjust the FOILS up or down so that the STOP PIN can be replaced in the TORQUE TUBE.

Insert the STOP PIN in until it is flush with the outside of the TORQUE TUBE.

Do not overtighten. The FOILS should rest on top of the STOP PIN. This pin will prevent the FOILS from dropping down and damaging the turnbuckle.

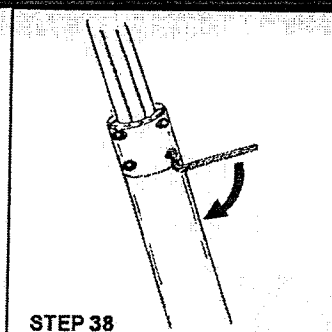

STEP 38

Tighten the CLAMP fasteners.

Make sure the grooves in the CLAMP align with the grooves in the FOILS.

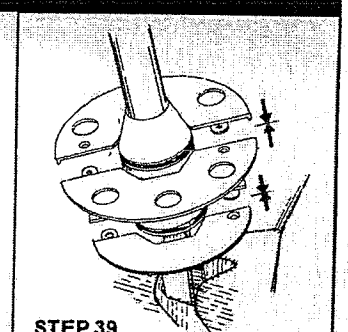

STEP 39

Replace BOTTOM and TOP PLATES on the LOWER DRUM ASSEMBLY.

We suggest that you tie or tape a line onto these plates to prevent them from accidentally being dropped overboard.

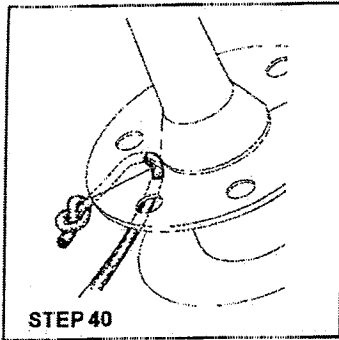

STEP 40

Add the control line to the TOP PLATE. Feed the line through the two holes and tie a figure eight knot as shown.

Line recommendation:

System

1100	50'(15m), 1/4"(6mm)
2100	70'(21m), 5/16"(8mm)
3100	90'(27m), 3/8"(10mm)

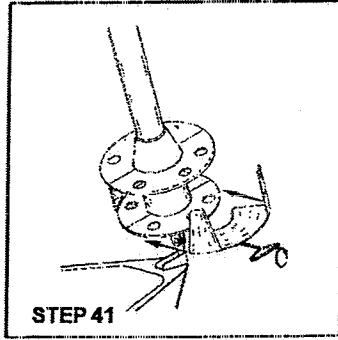

STEP 41

Install the STAINLESS CAGES with the special long handled Allen wrench provided in the kit.

Rotate the STAINLESS CAGES as required to insure a fair lead for the control line before tightening the screws.

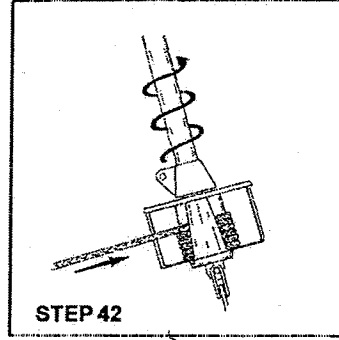

STEP 42

If your sails have been supplied with a sun cover sewn on the port side of the leach of the sail, rotate the entire furling system in a counter-clockwise direction to wind the control line onto the drum.

If your sails have the sun cover sewn on the starboard side, rotate the system in a clockwise direction.

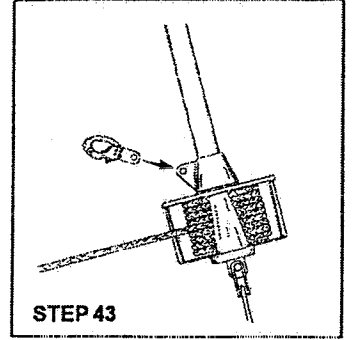

STEP 43

Attach the TACK SNAP SHACKLE to the ear on the bottom of the TORQUE TUBE.

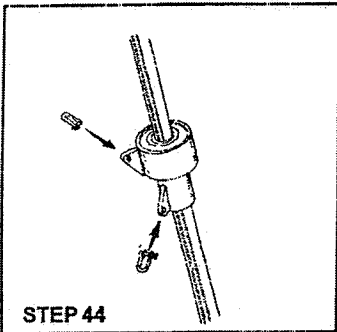

STEP 44

Attach the two "D" SHACKLES to the ears on the UPPER SWIVEL.

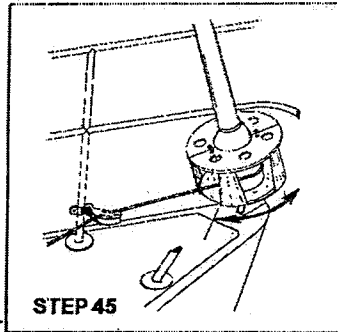

STEP 45

Check that the control line lead into the LOWER DRUM ASSEMBLY lines up with the middle of the DRUM.

The line should enter at 90° to the foils in the center of the drum.

Move the block up or down to provide a proper lead.

The pulpit block may be deck mounted with a backing plate to achieve a proper lead to the drum.

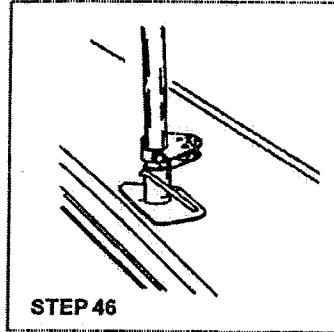

STEP 46

Install lead blocks on the stanchions to guide the control line back to the cockpit.

Adjust the final lead to a convenient location near the cockpit.

A deck or cam cleat allows for quick adjustment of the furling line.



Congratulations!

The furling system
is now complete and ready for
your jib.

Avoid Halyard Wrap

It is extremely important to inspect the final installation of the furler with the sail to insure that the angle of pull on the UPPER SWIVEL by the halyard is parallel to, or slightly aft of the angle of the headstay.

It may be necessary to utilize a Halyard Restrainer mounted on the mast to obtain the proper angle. Halyard restrainers should only be used if needed, as they limit sail luff length.

In addition, make sure that the UPPER SWIVEL is no more than 6" down from the TOP CAP. Use head or tack pendants to relocate the UPPER SWIVEL if it is too low.

Head pendants are preferable to tack pendants as they tend to keep the sailplan close to the deck to reduce heeling moment. Short tack pendants or a combination of head and tack pendants are acceptable to improve visibility under a low cut genoa.

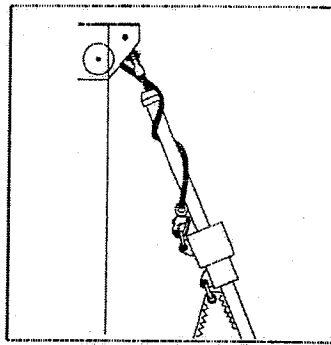

WARNING

Improper installation will increase the likelihood of the halyard becoming entangled or "wrapped" around the foils.

This condition could "lock-up" or damage the furler, halyard or headstay and could result in loss of the mast.

Please be diligent with your installation.



Note

Most boats DO NOT require modification of this angle when the upper swivel is raised to its proper location.

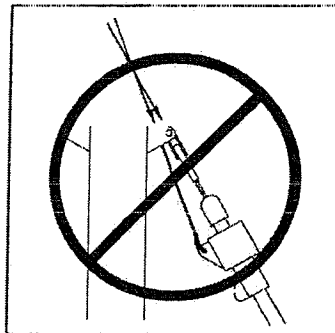

UNACCEPTABLE

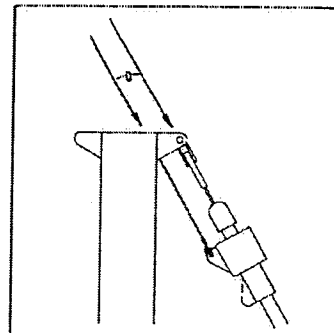

ACCEPTABLE

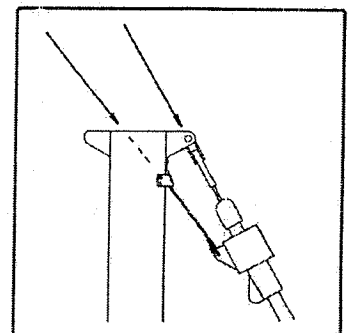

BEST

The restainer should be mounted as high as possible without contacting the foils when under load.

The deflection angle should be as small as possible to decrease friction in halyard tensioning.



Note

It may be necessary to utilize a plastic coated wire pendant if your sail is not long enough to position the halyard swivel properly.

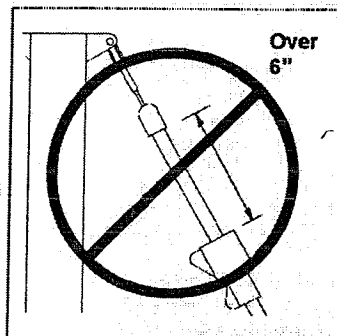

INCORRECT

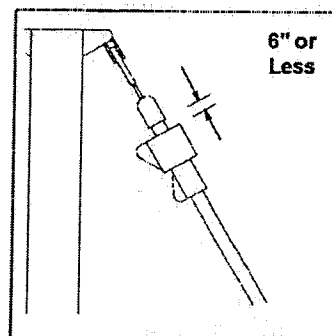

CORRECT

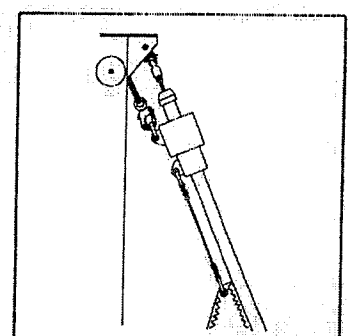

Typically used on storm jibs, this pendant should be permanently attached to the sail to insure proper location of the swivel regardless of sail changes.

Sail Requirements

Your Schaefer Furling/Reefing System has been designed for ease of operation for most typical headsails and furling conditions.

Often, your existing sails can be modified for use with our Furling/Reefing Systems. Most boats convert a 150% or 130% genoa as their primary furling sail. Local conditions may dictate a size smaller for particularly windy areas or slightly larger for very light wind locations.

All sails require hanks to be removed and replaced by luff tape (#6) that feeds into the extrusion sections to support the luff of your sail.

You may also wish to have a sun cover added to the leech of the sail to protect it from ultraviolet rays that can damage exposed sailcloth.



WARNING

The sail should be light enough for typical light-air conditions, yet have built-in reinforcement to handle heavy-air reefing.

A new sail can be designed to work with your furling system to handle a wide range of wind conditions.



Tech Tip

Although not required, many sailmakers recommend foam luff pads be sewn into the sail to help reduce draft in the middle of the sail as it is rolled on the headstay.

Storm Sails

Although your furling/reefing sail is designed for most conditions in your local sailing area, storm sails are part of a full sail inventory required for proper seamanship.

Heavy air working jibs and storm sails are required to cover the full range of wind that you may experience at sea. These sails require luff tape to allow them to be raised in the foils.

Because of their relatively small luff length compared to your multi-purpose genoa, pendants are required to position the upper swivel at its correct height at the masthead.

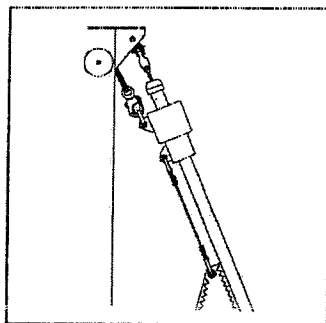

Tech Tip

It may be necessary to utilize a plastic coated wire pendant if your sail is not long enough to position the halyard swivel properly.

Typically used on storm jibs, this pendant should be permanently attached to the sail to insure proper location of the swivel regardless of sail changes.

Raising Sails

- 1) Attach the sheets to the clew of the sail.
- 2) Attach the tack of the sail to the tack shackle on the furling drum.
- 3) Attach the halyard to the upper shackle on the upper swivel.
- 4) Run the luff tape into the feeder and slide up the luff groove.
- 5) Attach the head to the lower shackle on the upper swivel.
- 6) Hoist the sail with an assistant feeding the luff tape into the feeder.

Caution should be used to ensure that spinnaker halyards do not get caught on the upper swivel, foils or jib halyard.

It may be necessary to move the spinnaker halyard block so that it will not interfere with the furling system.



WARNING

Do not force the sail into the feeder.

New sails are often stiff and must be given extra care when first being raised.



Idea

An optional pre-feeder is helpful if you intend to change sails often. Schaefer item no. 76-30 aligns your luff tape before it enters into the stainless feeder on the foil.



Tech Tip

Often, external halyards may be placed behind the spreaders to prevent interference with the furling system.

Schaefer Furling Systems

Furling Maintenance and Headstay Inspection Notes

The lower bearing should be flushed yearly (see page 20, inspection/maintenance of Schaefer installation instruction manual.)

The headstay turnbuckle should be inspected yearly and the mast should be checked for re-tuning, as wire stretches.

If the boat is left in a warm water environment, the system should be cleaned and the lower bearing checked and flushed before leaving the boat for any length of time.

In order to inspect the headstay and Schaefer's lower bearing unit, read the Schaefer installation manual instructions thoroughly and:

1. Remove the sail. Loosen the line on the drum. Flush the line of salt.
2. Support the mast properly with spare halyards.
3. Support the extrusions with a halyard using a rolling hitch under the feeder. Tension the halyard to insure the weight of the extrusions stay in place (page 22, step 1).
4. Loosen and remove the 4, 1/4" machine screws in the drum area (see page 22). Clean fasteners properly.
5. Back off the four Allenhead fasteners on the top of the torque tube (page 22, step 2). Lift the torque tube and inspect the turnbuckle, flush the lower bearing unit with water for a minute or two. Turn the lower bearing unit. Flush again. Use WD40 if no water is available. This should be done on a yearly basis. Lubrication is not necessary.
6. Clean the torque tube and heli coils (where fasteners are inserted) in order to wash any salt/corrosion from the system. Re-assemble using Duralac or Lanacote. Winch grease will work if no other anti-seize product is available.
7. Drum plates should be removed and cleaned (see page 22, step 5).
8. Wax lower portion of furler and extrusions or wipe down with mild cleaner or WD40.
9. Review page 22, 23 for assembly instructions. Please contact Schaefer Marine at 508-995-9511 with any questions or you can e-mail us at sales@schaefermarine.com

Pre-cut Headstay Installation

Used for new boats with a dealer installed furling system, or boats requiring a new swaged headstay .

In the Pre-cut Headstay (Bottom-Up) installation, you will not utilize a Sta-Lok™ fitting because a new headstay (with eye fitting, and screw stud on bottom) has been cut to length for use with this System.

This installation is designed for Dealer/ OEM installations with pre-determined headstay lengths and foils that have been marked or pre-cut at Schaefer, or boats requiring a new headstay.

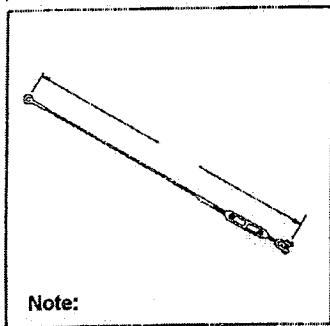

If you have an OEM dealer installed system, your headstay has been pre-cut to work with this Schaefer furling system.
DO NOT CUT YOUR HEADSTAY.

If you are designing a new headstay for use with this system please go to page 30 for fitting deductions and headstay cutting instructions.

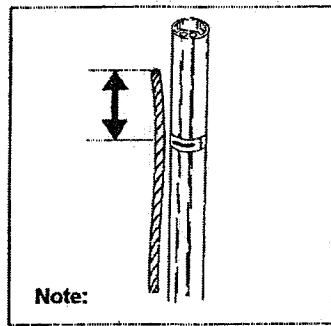

If you have an OEM dealer installed system, your UPPER FOIL has been marked or pre-cut for this system.

See Instructional Supplement supplied with your boat.

If you are designing a new headstay please go to page 31 for upper foil cutting instructions.

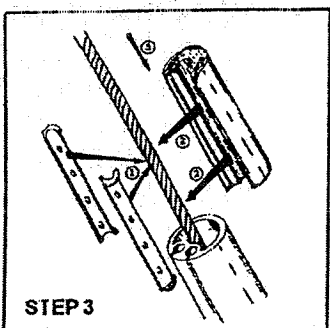

Place two LINERS on the wire. Snap the TOP JOINT onto the liners in the orientation shown. Slide the joint into the TOP FOIL.

The TOP JOINT has a "NUB" at the top and can be inserted only one way.

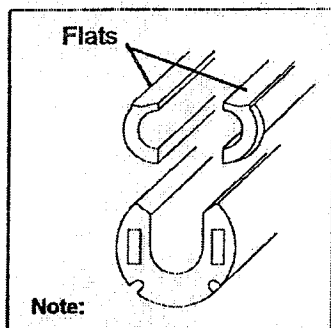

Be sure the liner flat sides are on the same side.

These JOINTS will use two piece liners which should be placed onto the wire and then snapped into the JOINT with the round side of the liners facing the inside of the JOINT.



WARNING

Do Not use this method for an Existing Headstay Installation used for most common owner or rigger retrofitting to existing 1x19 stainless wire or rod headstays.

Go To Pg. 5 Pg. for complete Existing Headstay Instructions for existing 1x19 stainless wire or rod headstays.

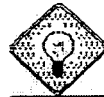

Note

Special instructional supplements pertaining to OEM systems are provided with each furling system.

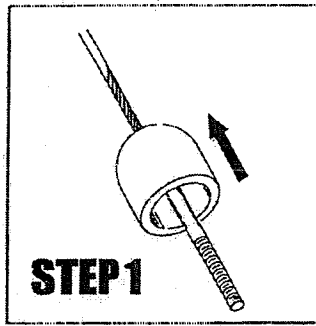

Starting with the headstay off the boat and the turnbuckle removed from the swage stud:

Slide the TOP CAP over the threaded turnbuckle swage stud and up the wire to the swage eye at the top of the wire.

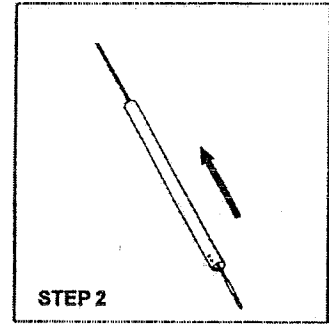

Slide the TOP FOIL over the threaded swage stud.

Be careful to install the end with no rivet holes facing the top of the system. The rivet holes at the bottom of the FOIL are required to join the next FOIL.

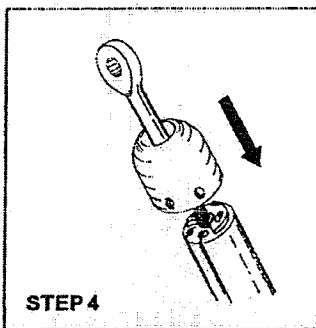

Cover the end of the TOP FOIL and TOP JOINT with the TOP CAP.

Align one of the two set screws in the TOP CAP with one of the two sail grooves and tighten both screws with the Allen wrench provided in the kit.

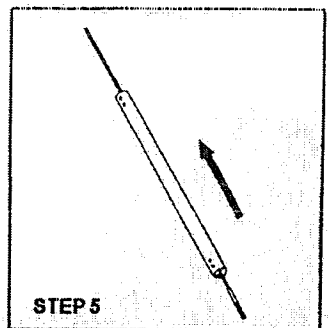

Slide either the HALF LENGTH FOIL or a FULL LENGTH FOIL over the threaded swage stud and up the wire to the bottom of the TOP FOIL.

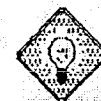

Note

Dealer/OEM Systems may be provided with special pre-cut foils. See Instructional Supplement supplied with your boat.

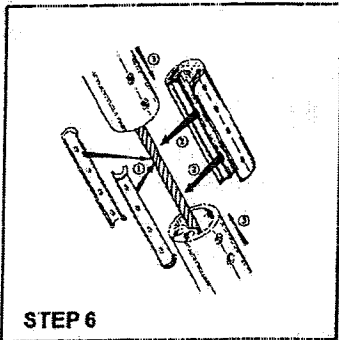

STEP 6

Insert a **STANDARD JOINT** between the two **FOILS**.

The **JOINT** has holes drilled to align with the rivet holes in the **FOIL**.

Make sure the rivets are fully inserted into the hole prior to engaging the rivet gun.

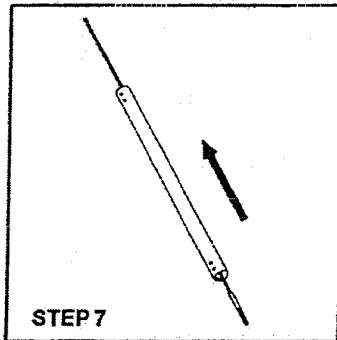

STEP 7

Repeat the operation of joining **FULL LENGTH FOILS** and **JOINTS** with all the remaining **FULL LENGTH FOILS**.

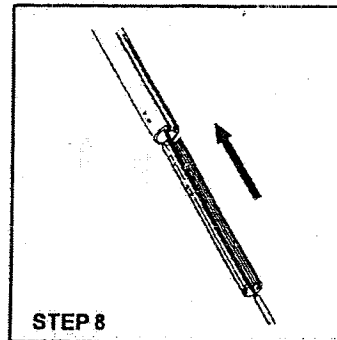

STEP 8

Insert the long **BOTTOM JOINT** into the last **FULL LENGTH FOIL** and rivet together.

The **BOTTOM JOINT** has holes at the top end. The top set of holes will align with the rivet holes in the bottom of the **FULL LENGTH FOIL**.

Be sure end with rivet holes is up.

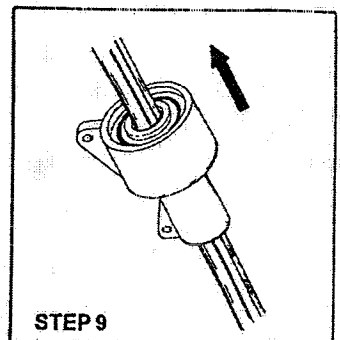

STEP 9

Slide the **UPPER SWIVEL** onto the **FOILS** at this time.

Make sure the large portion of the swivel is up!

We suggest that you tie off, or tape the **SWIVEL** to the **FOILS** so that it will not accidentally slide down when the system is raised on the boat.

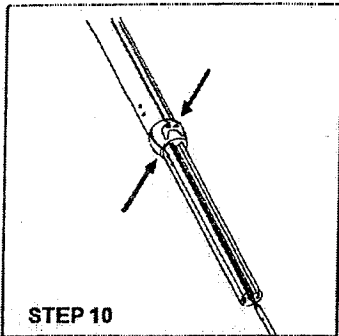

STEP 10

Assemble the stainless **SAIL FEEDER** onto the long **BOTTOM JOINT** just below the bottom of the last **FULL LENGTH FOIL**.

The **SAIL FEEDER** should butt up against the **FOIL**.

Be sure the grooved end faces up.

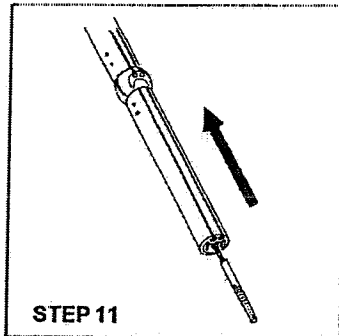

STEP 11

Assemble the **BOTTOM FOIL** over the **BOTTOM JOINT**.

The top of this **FOIL** has a set of holes to align with the second set of rivet holes in the **BOTTOM JOINT**.

The **BOTTOM FOIL** should butt up against the bottom of the **SAIL FEEDER**.

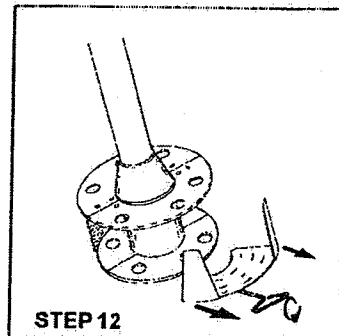

STEP 12

Loosen the captive screws on the **STAINLESS CAGES** and remove them from the **LOWER DRUM AND TORQUE TUBE ASSEMBLY**.

These two screws are captivated in the collars and only need to be loosened for removal of the cages.

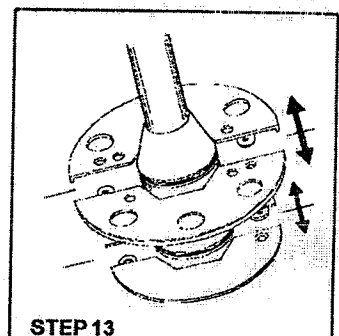

STEP 13

Remove the flat head fasteners from the **TOP** and **BOTTOM PLATES**.

Remove the **TOP** and **BOTTOM PLATES** from the **DRUM ASSEMBLY**.

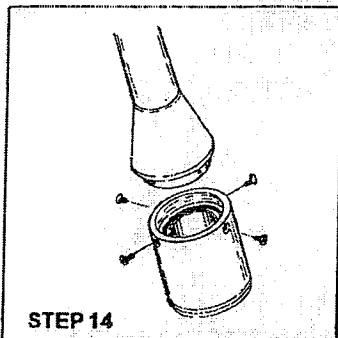

STEP 14

Remove the four flat head fasteners from the side of the **LOWER SWIVEL** and lift off the **TORQUE TUBE**.

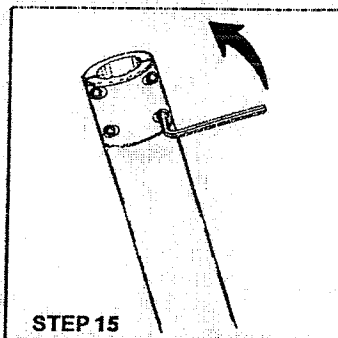

STEP 15

Loosen the **CLAMP** at the top of the **TORQUE TUBE**.

An Allen wrench is provided for this procedure.

The screws are captivated in the clamp and only need to be loosened.

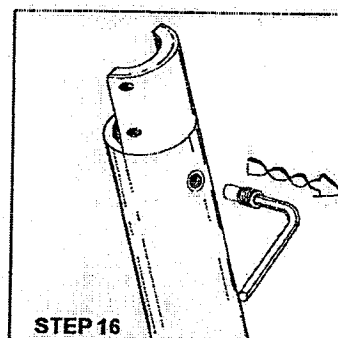

STEP 16

Remove the **STOP PIN** from the side of the **TORQUE TUBE**.

An Allen wrench is provided for this procedure.

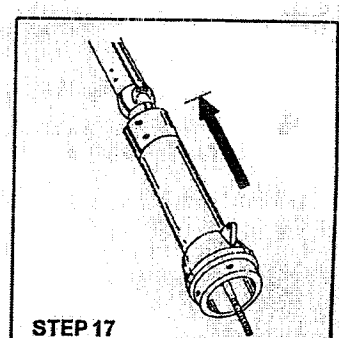

STEP 17

Slide the **TORQUE TUBE** over the threaded swage stud and onto the **BOTTOM FOIL**.

Slide it up until the upper end comes in contact with the stainless **SAIL FEEDER**.

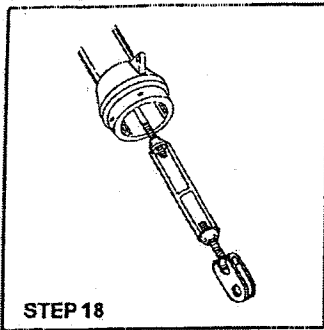

STEP 18

Thread the lower portion of the turnbuckle onto the threaded swage stud. Do not "tighten" turnbuckle more than is required to place cotter pins in the stud holes.

Do not bend over pins more than is needed to keep them captive. You will need to remove them for final adjustment.

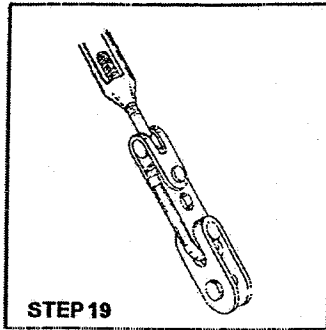

STEP 19

Add the INTEGRAL TOGGLE/LINK to the bottom of the turnbuckle.

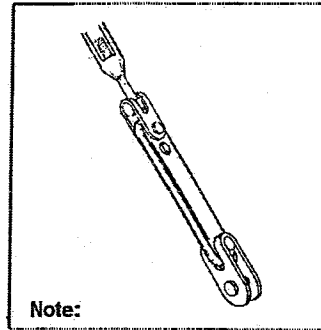

Note:

It may be necessary to install a LONG INTEGRAL TOGGLE/ LINK at the bottom of the system in order to raise the drum above any obstructions.

Dealer installed OEM Systems may be provided with this LONG INTEGRAL TOGGLE/ LINK. See Instructional Supplement supplied with your boat.

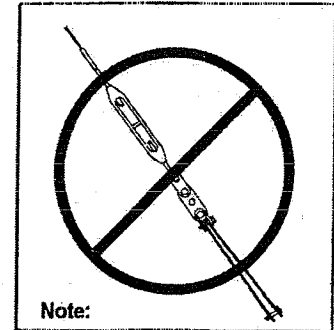

Note:

DO NOT use dual link tangs attached to the end of the toggle

There is a risk of failure if you use this configuration without a toggle at the stemhead fitting.

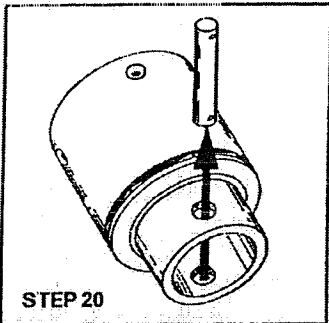

STEP 20

Remove the STAINLESS BASE PIN from the bottom of the LOWER SWIVEL.

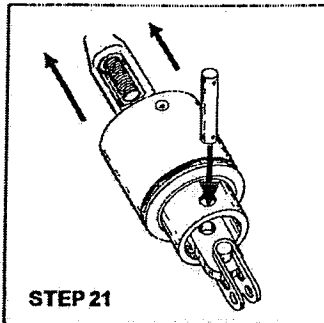

STEP 21

Slide the LOWER SWIVEL over the INTEGRAL TOGGLE/LINK and replace the STAINLESS BASE PIN through the hole provided in the INTEGRAL TOGGLE/LINK.

Replace the COTTER PINS in the BASE PIN.

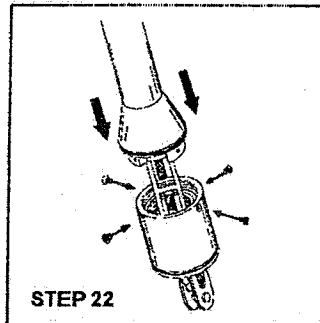

STEP 22

Slide the TORQUE TUBE down into the LOWER SWIVEL and re-fasten.

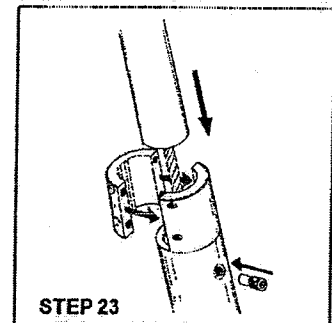

STEP 23

Replace the STOP PIN and slide the BOTTOM FOIL down into the top of the TORQUE TUBE until it comes in contact with the STOP PIN.

Tighten the CLAMP, making sure that the grooves on the inner face of the CLAMP are lined up with the grooves in the FOIL.



Congratulations!

The furler is now partially assembled and ready to be installed on the boat.

In preparation for hauling the system aloft:

Slide the UPPER SWIVEL down the FOILS until it rests on top of the SAIL FEEDER. Tape or tie the swivel in place.

If the swivel is not lowered down the system at this time, there is a risk that it will slide down in an uncontrolled manner when the system is being raised to the masthead, causing injury to you or your assistants.

If the UPPER SWIVEL binds on any of the JOINTS, the rivet heads should be checked to assure they are flush.



WARNING

Do not try to lift the system from or with the Bosun's chair.

Use a second halyard to adjust the system into position and replace the rigging pin at the masthead.

Once the masthead pin is in place, swing the drum unit into position and pin at the stemhead.

Make sure upper and lower cotter pins are properly bent.

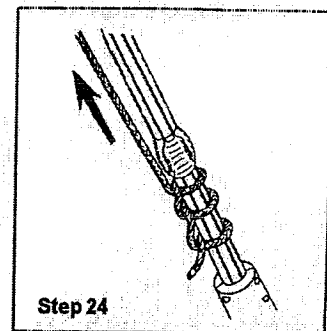

Step 24

Once the system is fitted to the boat, you must adjust your turnbuckle one final time to tune your rig.

Support the FOILS with the jib halyard by tying a series of half hitches below the FEEDER, then take up the slack on the halyard.

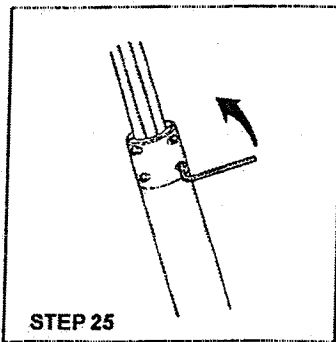

STEP 25
Loosen the four fasteners in the CLAMP, and remove the STOP PIN.

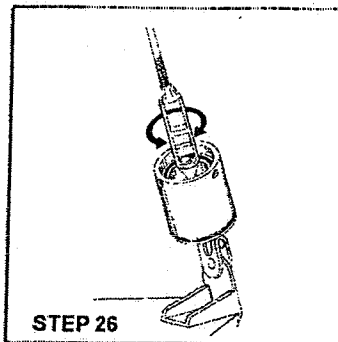

STEP 26
Remove the four fasteners holding the TORQUE TUBE to the LOWER SWIVEL. Slide the TORQUE TUBE up to reveal the turnbuckle.

Adjust the turnbuckle as required to tighten the headstay and tune the rig. Replace and set the cotter pins to prevent the turnbuckle from unthreading.

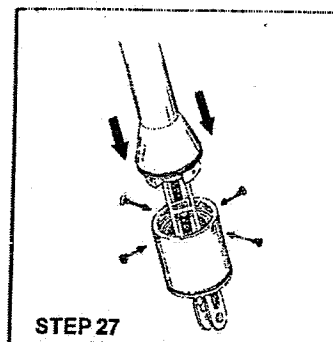

STEP 27
Lower the TORQUE TUBE back down onto the LOWER SWIVEL and replace the fasteners.

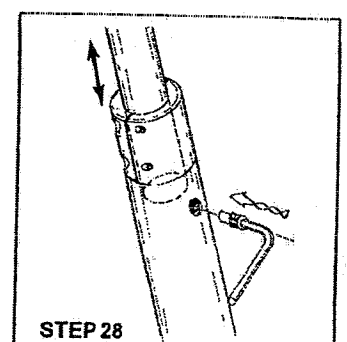

STEP 28
Adjust the FOILS up or down so that the STOP PIN can be replaced. The FOILS should rest on top of the STOP PIN.

Insert the STOP PIN up to the point of being flush with the TORQUE TUBE.

Do not overtighten.

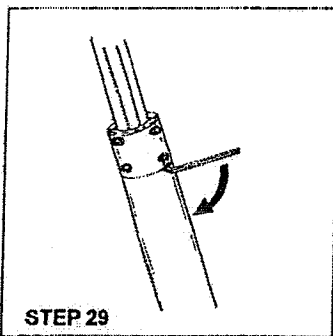

STEP 29
Tighten the fasteners of the CLAMP. Make sure that the two extruded wedges on the inside of the CLAMP align with the two sail grooves in the FOIL.

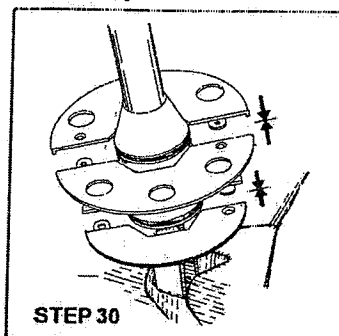

STEP 30
Replace the BOTTOM and TOP PLATES.

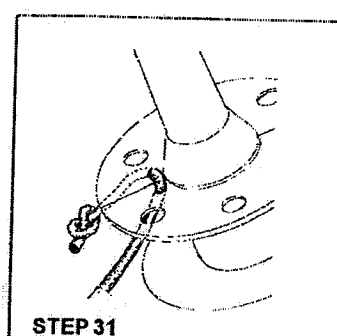

STEP 31
Add the control line to the TOP PLATE. Feed the line through the two holes and tie a figure eight knot as shown.

Line recommendation:

System	
1100	50'(15m), 1/4"(6mm)
2100	70'(21m), 5/16"(8mm)
3100	90'(27m), 3/8"(10mm)

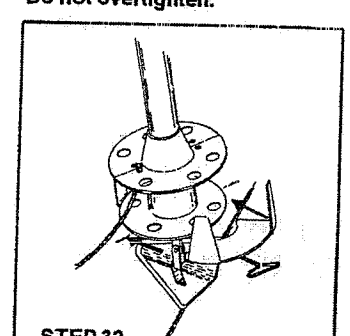

STEP 32
Install the STAINLESS CAGES with the special long handled Allen wrench provided in the kit.

Rotate the STAINLESS CAGES as required to insure a fair lead for the control line before tightening the screws.

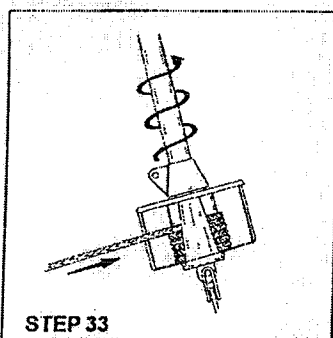

STEP 33
If your sails have been supplied with a sun cover sewn on the port side of the leach, rotate the furling system in a counter-clockwise direction to wind the control line onto the drum.

If your sails have the sun cover sewn on the starboard side, rotate the system in a clockwise direction.

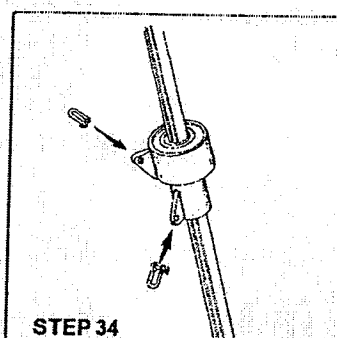

STEP 34
Attach the Tack Shackle to the ear on the TORQUE TUBE collar and the "D" Shackles to the two ears on the UPPER SWIVEL.

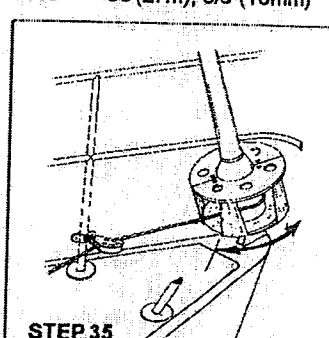

STEP 35
Check that the control line lead into the LOWER DRUM ASSEMBLY lines up with the middle of the DRUM.

The line should enter the drum at 90° to the foils.

Move the block up or down to provide a proper lead.

The pulpit block may be deck mounted with a backing plate to achieve a proper lead to the drum.

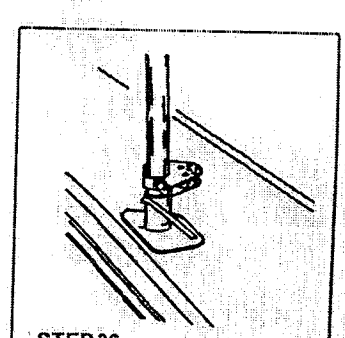

STEP 36
Install lead blocks on the stanchions to guide the control line back to the cockpit.



Congratulations!

The furling system is now complete and ready for your jib.

Avoid Halyard Wrap

It is extremely important to inspect the final installation of the furler with the sail to insure that the angle of pull on the UPPER SWIVEL by the halyard is parallel to, or slightly aft of the angle of the headstay.

It may be necessary to utilize a Halyard Restrainer mounted on the mast to obtain the proper angle. Halyard restrainers should only be used if needed, as they limit sail luff length.

In addition, make sure that the UPPER SWIVEL is no more than 6" down from the TOP CAP. Use head or tack pendants to relocate the UPPER SWIVEL if it is too low.

Head pendants are preferable to tack pendants as they tend to keep the sailplan close to the deck to reduce heeling moment. Short tack pendants or a combination of head and tack pendants are acceptable to improve visibility under a low cut genoa.

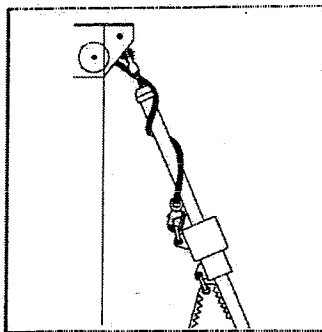

This condition could "lock-up" or damage the furler, halyard or headstay and could result in loss of the mast.

Please be diligent with your installation.



WARNING

Improper installation will increase the likelihood of the halyard becoming entangled or "wrapped" around the foils.



Note

Most boats DO NOT require modification of this angle when the upper swivel is raised to its proper location.

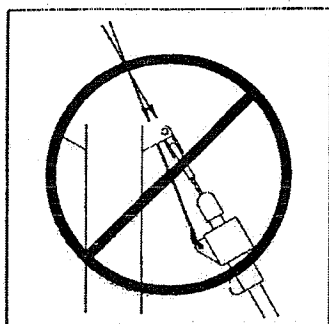

UNACCEPTABLE

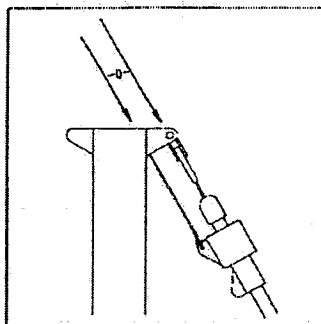

ACCEPTABLE

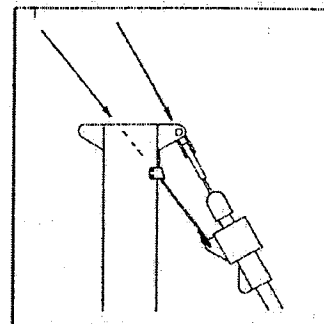

BEST

The restrainer should be mounted as high as possible without contacting the foils when under load.

The deflection angle should be as small as possible to decrease friction in halyard tensioning.

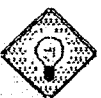

Note

It may be necessary to utilize a plastic coated wire pendant if your sail is not long enough to position the halyard swivel properly.

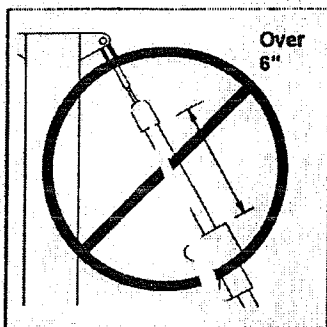

INCORRECT

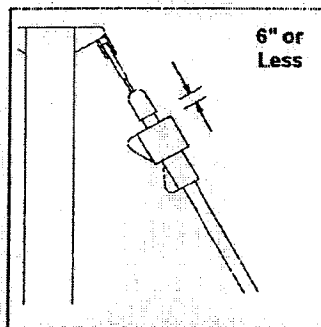

CORRECT

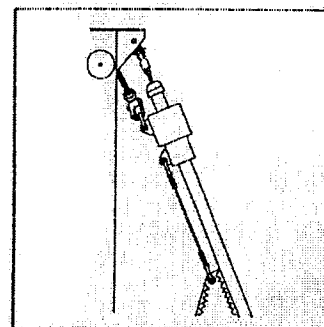

Typically used on storm jibs, this pendant should be permanently attached to the sail to insure proper location of the swivel regardless of sail changes.

Sail Requirements

Your Schaefer Furling/Reefing System has been designed for ease of operation for most typical headsails and furling conditions.

Often, your existing sails can be modified for use with our Furling/Reefing Systems. Most boats convert a 150% or 130% genoa as their primary furling sail. Local conditions may dictate a size smaller for particularly windy areas or slightly larger for very light wind locations.

All sails require hanks to be removed and replaced by luff tape (#6) that feeds into the extrusion sections to support the luff of your sail.

You may also wish to have a sun cover added to the leech of the sail to protect it from ultraviolet rays that can damage exposed sailcloth.



WARNING

The sail should be light enough for typical light-air conditions, yet have built-in reinforcement to handle heavy-air reefing.

A new sail can be designed to work with your furling system to handle a wide range of wind conditions.



Tech Tip

Although not required, many sailmakers recommend foam luff pads be sewn into the sail to help reduce draft in the middle of the sail as it is rolled on the headstay.

Storm Sails

Although your furling/reefing sail is designed for most conditions in your local sailing area, storm sails are part of a full sail inventory required for proper seamanship.

Heavy air working jibs and storm sails are required to cover the full range of wind that you may experience at sea. These sails require luff tape to allow them to be raised in the foils.

Because of their relatively small luff length compared to your multi-purpose genoa, pendants are required to position the upper swivel at its correct height at the masthead.

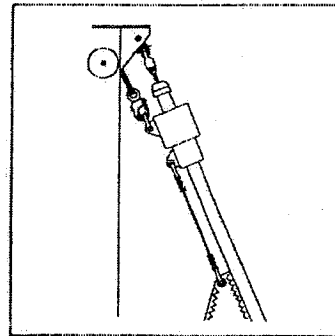

Tech Tip

It may be necessary to utilize a plastic coated wire pendant if your sail is not long enough to position the halyard swivel properly.

Typically used on storm jibs, this pendant should be permanently attached to the sail to insure proper location of the swivel regardless of sail changes.

Raising Sails

- 1) Attach the sheets to the clew of the sail.
- 2) Attach the tack of the sail to the tack shackle on the furling drum.
- 3) Attach the halyard to the upper shackle on the upper swivel.
- 4) Run the luff tape into the feeder and slide up the luff groove.
- 5) Attach the head to the lower shackle on the upper swivel.
- 6) Hoist the sail with an assistant feeding the luff tape into the feeder.

Caution should be used to ensure that spinnaker halyards do not get caught on the upper swivel, foils or jib halyard.

It may be necessary to move the spinnaker halyard block so that it will not interfere with the furling system.



WARNING

Do not force the sail into the feeder.

New sails are often stiff and must be given extra care when first being raised.



Idea

An optional pre-feeder is helpful if you intend to change sails often. Schaefer item no. 76-30 aligns your luff tape before it enters into the stainless feeder on the foil.



Tech Tip

Often, external halyards may be placed behind the spreaders to prevent interference with the furling system.

Inspection/Maintenance

Prudent seamanship dictates that your furling system and all of your marine hardware receive regular inspections for deformation, wear, cracks and corrosion.



WARNING

Even if your boat has had little use, corrosion or the endless rocking action of the boat at the mooring may cause damage that could affect the strength of the fittings.

If, after inspection, you are in doubt about the integrity or safety of any of your Schaefer fittings, send them to our factory and we will inspect them at no charge.

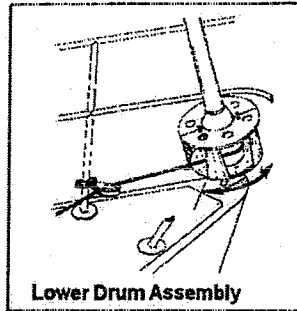

Lower Drum Assembly

Rinse with soap and water whenever you wash your boat.

Lower drum assembly must be flushed on a regular basis to prevent corrosion.

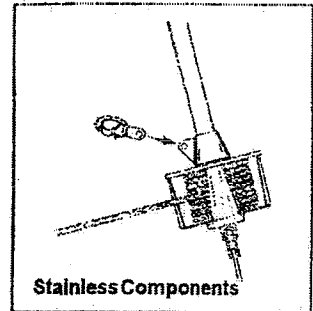

Stainless Components

All stainless steel will rust to a certain degree due to a natural chemical reaction to air and salt water particularly where there is abrasion, friction or welds. The problem though is mainly cosmetic and is solved with metal polish and frequent fresh water rinsing.

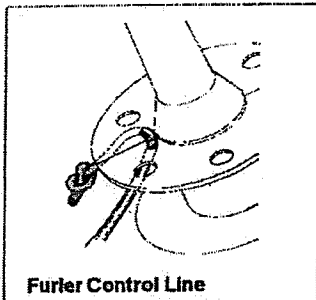

Furler Control Line

Check for wear or contact with the drum plates or stainless cages.

You may wish to "end-for-end" the line to extend its usable life.

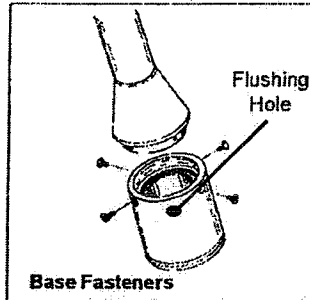

Base Fasteners

Check for loosening or possible accidental loss.

Flush lower bearing with fresh water monthly. Loosen the furling line for access to the flushing hole. Spray water into the hole with a hose. Rotate the drum and repeat several times. ***

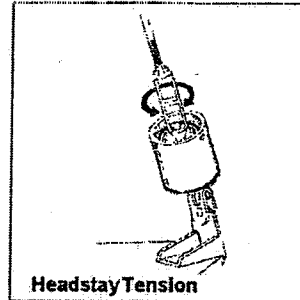

Headstay Tension

Check for possible loosening or excessive play.

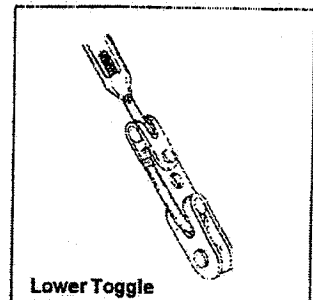

Lower Toggle

Check for wear, cracks or stress corrosion.

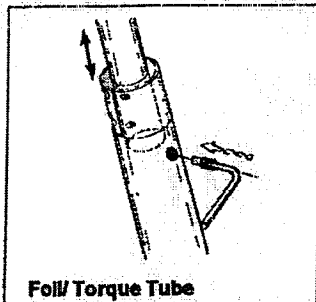

Foil/Torque Tube

Check stop pin and foil position. The foils should rest on top of the stop pin.

The stop pin should be flush with the outside of the torque tube. Do not over tighten.

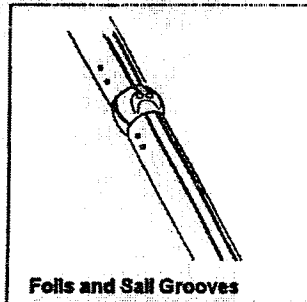

Foils and Sail Grooves

Clean and then spray grooves with Teflon™ lubricant to reduce sail friction.

Wax the foils with a UV inhibitive wax once a season.

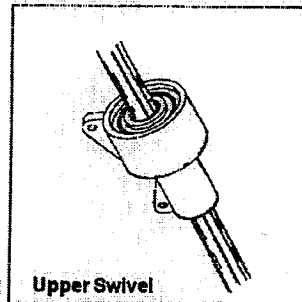

Upper Swivel

Occasionally lower the sail on a calm day and rinse the upper swivel with soap and fresh water. The Torlon™ bearings do not require lubrication but should be rinsed free of dirt and salt build-up or pollutants.

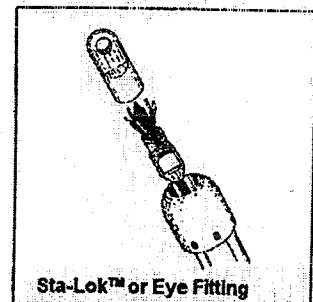

Sta-Lok™ or Eye Fitting

Check for wear or unraveling of the headstay wire. Check fitting for loosening, corrosion, or contact with the foils.

Please reference the provided Sta Lok™ Fitting Instructions for complete details.

*** 2100 modification effective June, 2004

Operation/ Furling

For All Systems

To furl or completely roll up the sail, ease the genoa sheets and pull the furling line. It's that easy! In light-air, it may be necessary to apply light tension on the jib sheet to insure that it furls properly. Without tension, the jib may furl very loosely around the foil.

If you leave the jib in this condition there is a risk that when the sail is exposed to a brisk breeze it will tighten itself around the furler and a portion of the clew will begin to flog. In heavy-air, you may need to luff the sail completely to furl.



WARNING

DO NOT force a system to turn with a winch. Check for obstructions that may be preventing the system from rotating.

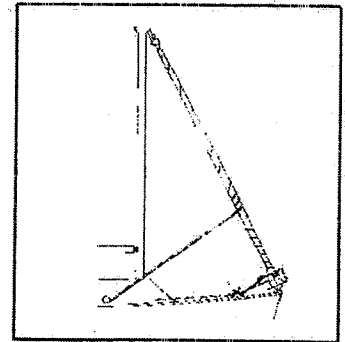
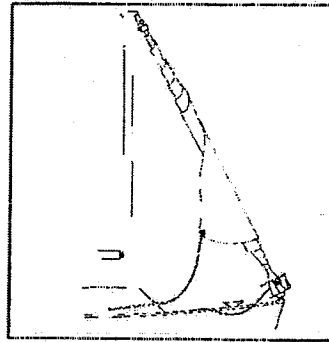

It is often the case when returning to the harbor at the end of a day of sailing that there is little or no wind, perhaps you are even under power. If you furl the sail in these conditions you will notice that the jib rolls up very loose and uneven.

Prevent this from happening by keeping light pressure on the jib sheets when furling the sail and by rolling the systems a few extra turns so that the jib sheets are wrapped around the sail several times.

Reefing

Reefing, or reducing the sail to a size appropriate for the sailing conditions can be accomplished with almost any headsail that has been modified for use with our system.

Your genoa may be reefed to reduce heeling, improve visibility or slow the boat in tight quarters or with a limited crew.

Although not required, many sailmakers recommend foam luff pads be sewn into the sail to help reduce draft in the middle of the sail as it is rolled on the headstay. This is generally an easy conversion that will give your genoa a more desirable shape when reefed.



Tech Tip

Marking the foot of the sail, or furling control line is helpful in determining the proper positions of the headsail on your boat.

You may also mark lead block positions on your jib lead tracks or toe rail that should be changed to the corresponding position of the reefed genoa.



Idea

Adjustable lead car systems like Schaefer item no's. 17-51 or 17-39 are excellent compliments to a quick reefing lead system.

Securing the System For Storm Conditions

The jib must be tightly and completely furled on the furling system and the control line cleated securely before you leave your boat.

In addition to securing the control line it is also advisable to tie off the drum with a short length of line as a measure of safety. The safety line will prevent damage that could occur if someone working on your boat inadvertently released the control line prior to leaving the boat.



WARNING

We advise you to remove the jib when you leave the boat unattended for any length of time or prior to severe storms.

This will reduce windage, helping to minimize pressure on the mooring or anchoring equipment.

Turnbuckle Adjustment

All Schaefer Systems allow for easy access to the turnbuckle for full headstay adjustment.

Slack the backstay turnbuckle tensioning device and ease the mainsheet or vang.

Remove the headsail from the furler. Remove the furling control line.

Refer to these instructions for future turnbuckle adjustment to your system to tune your rig.

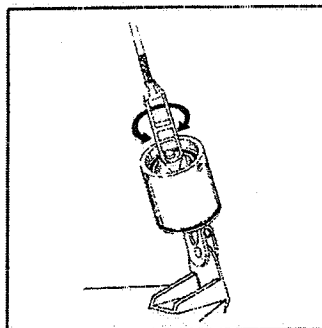

Your headstay should be tight for proper furling operation.



Tech Tip

A loose headstay may cause excessive wear on the joints, and may be more difficult to rotate.

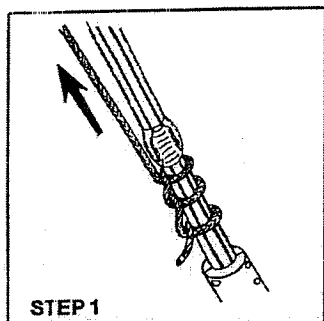

Support the FOILS with the jib halyard by tying a series of half hitches below the SAIL FEEDER, then take up the slack on the halyard.

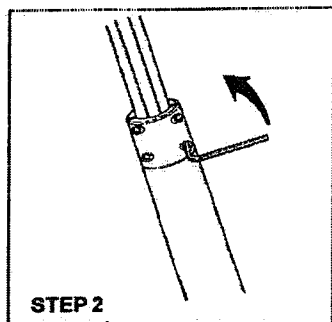

Loosen the four Allen head fasteners in the top of the TORQUE TUBE.

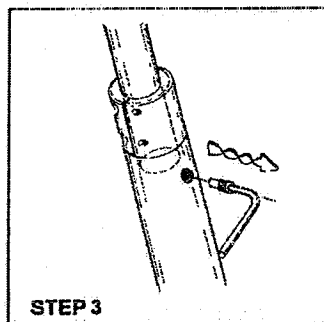

Remove the STOP PIN from the side of the TORQUE TUBE.

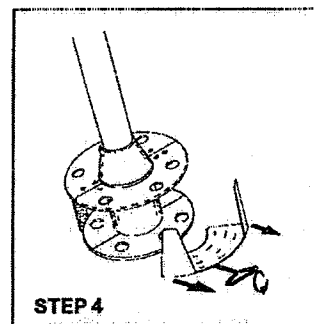

Loosen the captive screws on the STAINLESS CAGES and remove them from the LOWER DRUM AND TORQUE TUBE ASSEMBLY.

These two screws are captivated in the collars and only need to be loosened for removal of the cages.

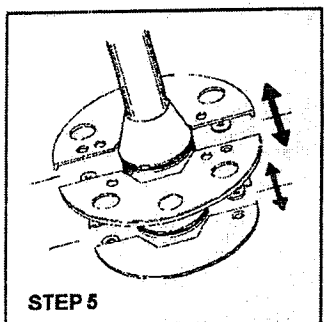

Remove the TOP and BOTTOM PLATES from the DRUM ASSEMBLY.

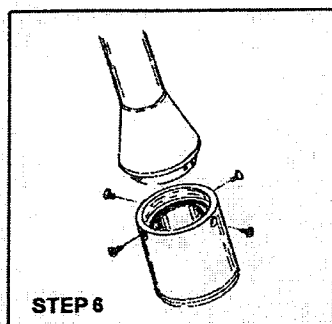

Remove the four fasteners holding the TORQUE TUBE to the LOWER SWIVEL.

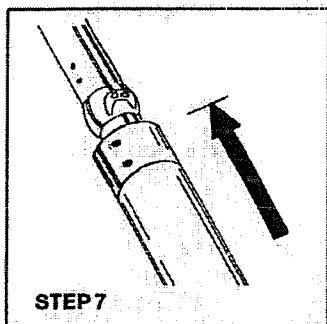

Slide the torque tube assembly up to expose the bottom of the turnbuckle.

Tighten the clamp screws to hold the unit up.

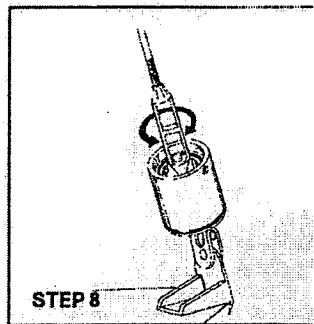

Adjust the turnbuckle as required to tighten the headstay and tune the rig. Replace and set the cotter pins to prevent the turnbuckle from unthreading.

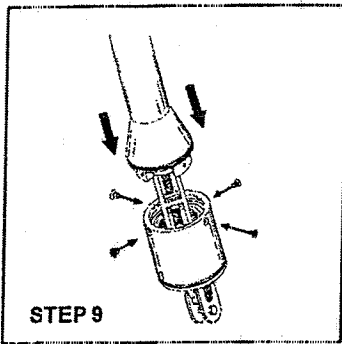

STEP 9

Lower the TORQUE TUBE back down onto the LOWER SWIVEL and replace the fasteners.

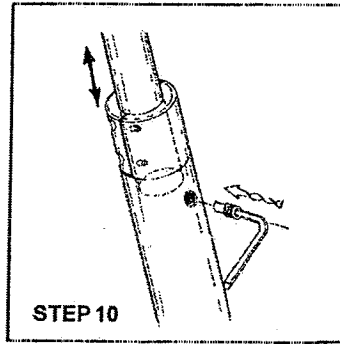

STEP 10

Adjust the FOILS up or down so that the STOP PIN can be replaced in the TORQUE TUBE.

Insert the STOP PIN in until it is flush with the outside of the TORQUE TUBE.



WARNING

Do not overtighten.
The FOILS should rest on top of the STOP PIN.
This pin will prevent the FOILS from dropping down and damaging the turnbuckle.

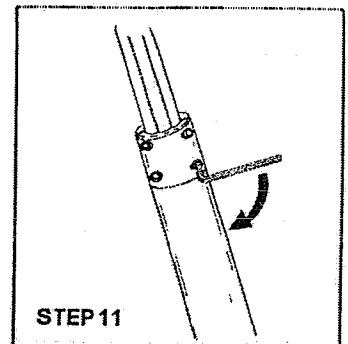

STEP 11

Tighten the CLAMP fasteners.

Make sure the grooves in the CLAMP align with the grooves in the FOILS.

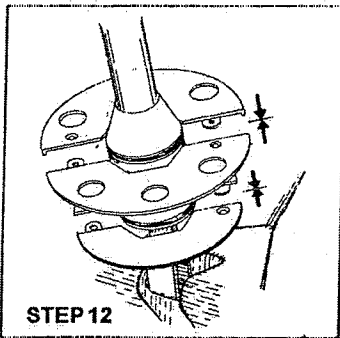

STEP 12

Replace BOTTOM and TOP PLATES on the LOWER DRUM ASSEMBLY.

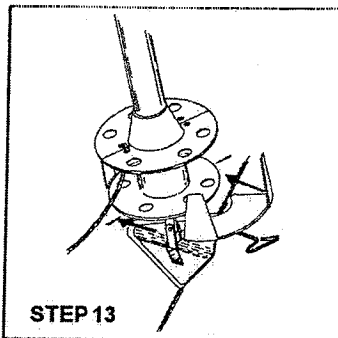

STEP 13

Install the STAINLESS CAGES with the special long handled Allen wrench provided in the kit.

Rotate the STAINLESS CAGES as required to insure a fair lead for the control line before tightening the screws.



Note

Remove the halyards.
Tighten the backstay turnbuckle and reinstall cotter pins in the turnbuckle.
Attach the furling control line.
Attach jib and you're done!

Backstay Adjusters

Backstay tension can be used to keep the headstay tight for proper furling and reefing. Tension may be eased when you leave your boat, or when sailing downwind.

Caution should be used when completely slacking backstay tension to insure that the foil does not jam into the headstay terminal. Your System should be assembled with enough exposed headstay between the foils and the terminal to allow for adjustment in mast rake.

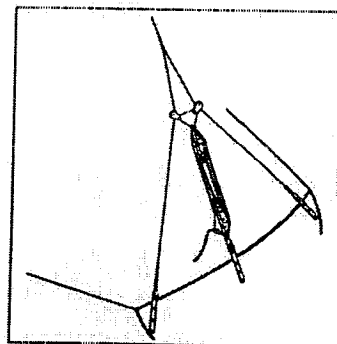

Block and tackle, mechanical or hydraulic backstay adjusters all allow you modify headstay tension to adjust sail shape to various wind conditions.



WARNING

Backstay adjusters should be tensioned prior to halyard tensioning to prevent over tensioning of the halyard that could damage your sail or furling system.

Conversion For Racing

All Schaefer Furling systems can be easily converted for use as a headstay foil. This will allow you to use "full hoist" racing sails and also allow you to change headsails without going "bare headed".

Twin aft-facing sail grooves allow carrying two sails at once or quick sail changes. Standard, split drum plates are easily removed, and our specially shaped feeder provides smooth sail entry to prolong sail life.

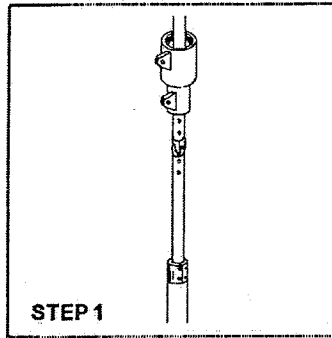

STEP 1
Unfurl the sail and lower the halyard. Remove the sail from the system.

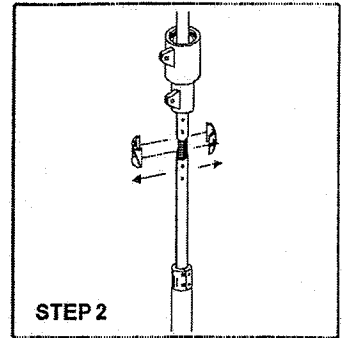

STEP 2
Remove the two SAIL FEEDER pieces carefully to allow the UPPER SWIVEL to slide below the FEEDER position.

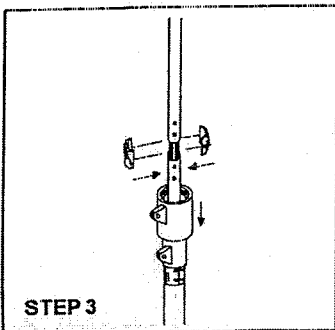

STEP 3
Slide the UPPER SWIVEL down until it rests on top of the TORQUE TUBE.

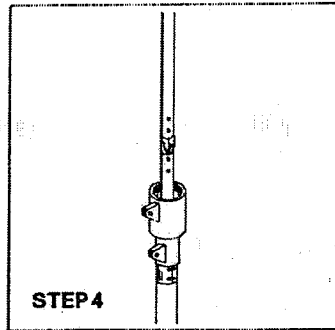

STEP 4
The feeder is now clear to accept a full length sail.

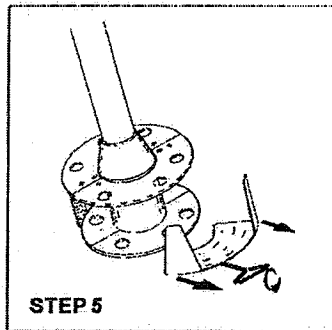

STEP 5
Loosen the captive screws on the STAINLESS CAGES and remove them from the LOWER DRUM AND TORQUE TUBE ASSEMBLY.

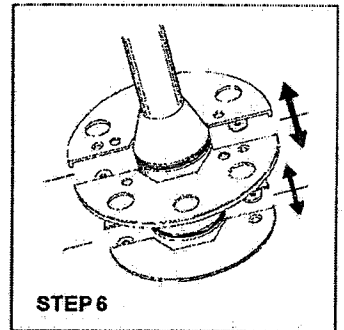

STEP 6
Remove the control line and TOP and BOTTOM PLATES from the DRUM ASSEMBLY.

Replace the SAIL FEEDER.

The halyard can now be attached directly to the head of the sail, and the tack can be attached directly to the stemhead fitting.

Trailing

If you intend to trailer your boat, we suggest that you remove the sail, drum unit, and bottom portion of the turnbuckle from the system. This will prevent the sail from chafing on the mast or other rigging.

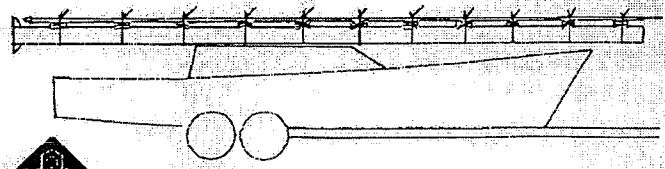
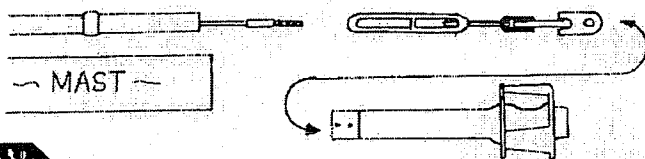

WARNING

Inspect all furler and mast hardware before re-stepping and re-rigging the sail.

Vibration, caused by extended trailing can loosen screws and cause chafe on lines.



Tech Tip

Removing the drum unit will shorten the overall length of the system, so that the foils can be secured against the mast. Secure the drum unit inside the boat.

Tie the foils to the mast at regular intervals, using scrap pieces of foam to prevent the foils from chafing against the mast.

Schaefer Furling Systems

Furling Maintenance and Headstay Inspection Notes

The lower bearing should be flushed yearly (see page 20, inspection/maintenance of Schaefer installation instruction manual.)

The headstay turnbuckle should be inspected yearly and the mast should be checked for re-tuning, as wire stretches.

If the boat is left in a warm water environment, the system should be cleaned and the lower bearing checked and flushed before leaving the boat for any length of time.

In order to inspect the headstay and Schaefer's lower bearing unit, read the Schaefer installation manual instructions thoroughly and:

1. Remove the sail. Loosen the line on the drum. Flush the line of salt.
2. Support the mast properly with spare halyards.
3. Support the extrusions with a halyard using a rolling hitch under the feeder. Tension the halyard to insure the weight of the extrusions stay in place (page 22, step 1).
4. Loosen and remove the 4, ¼" machine screws in the drum area (see page 22). Clean fasteners properly.
5. Back off the four Allenhead fasteners on the top of the torque tube (page 22, step 2). Lift the torque tube and inspect the turnbuckle, flush the lower bearing unit with water for a minute or two. Turn the lower bearing unit. Flush again. Use WD40 if no water is available. This should be done on a yearly basis. Lubrication is not necessary.
6. Clean the torque tube and heli coils (where fasteners are inserted) in order to wash any salt/corrosion from the system. Re-assemble using Duralac or Lanacote. Winch grease will work if no other anti-seize product is available.
7. Drum plates should be removed and cleaned (see page 22, step 5).
8. Wax lower portion of furler and extrusions or wipe down with mild cleaner or WD40.
9. Review page 22, 23 for assembly instructions. Please contact Schaefer Marine at 508-995-9511 with any questions or you can e-mail us at sales@schaefermarine.com

SYSTEM 1100 SCHEMATIC

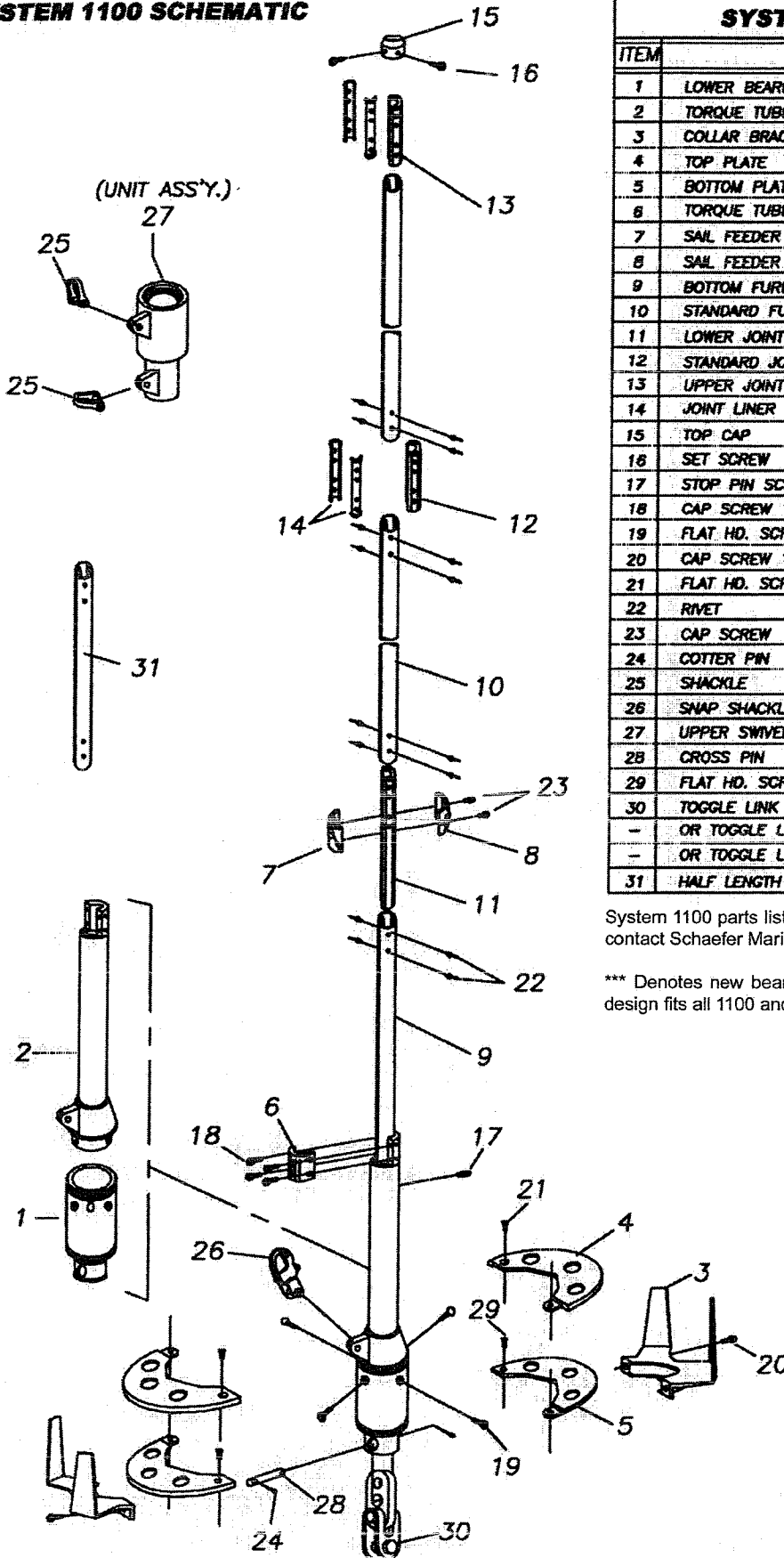

SYSTEM 1100 PARTS LIST

ITEM	DESCRIPTION	PART #	QTY.
1	LOWER BEARING ASSEMBLY***	33-051-A	1
2	TORQUE TUBE	33-030-A1	1
3	COLLAR BRACKET PLATE	45-230-A	2
4	TOP PLATE	35-328	2
5	BOTTOM PLATE	35-327	2
6	TORQUE TUBE CLAMP	32-025-02	1
7	SAIL FEEDER FRONT HALF	45-223-01	1
8	SAIL FEEDER BACK HALF	45-223-02	1
9	BOTTOM FURL EXTRUSION	14-034-M01	1
10	STANDARD FURL EXTRUSION - 72" LG.	14-034-M02	6
11	LOWER JOINT	14-060-01	1
12	STANDARD JOINT	14-060-02	6
13	UPPER JOINT (NO RIVET HOLES)	14-060-03	1
14	JOINT LINER	25-288-01	14
15	TOP CAP	32-014	1
16	SET SCREW	22-060	2
17	STOP PIN SCREW	24-045	1
18	CAP SCREW 10-24 X 5/8" LG.	24-057	4
19	FLAT HD. SCREW 1/4-20 X 1/2" LG.	22-131	4
20	CAP SCREW 1/4-20	24-058	2
21	FLAT HD. SCREW 10-24 X 1/4" LG.	22-352	4
22	RIVET	30-067	70
23	CAP SCREW	24-055	2
24	COTTER PIN	51-012-16	2
25	SHACKLE	93-12	2
26	SNAP SHACKLE	45-21	1
27	UPPER SWIVEL UNIT ASS'Y.***	33-050-A1	1
28	CROSS PIN	51-233	1
29	FLAT HD. SCREW 10-24x5/16"	22-328	1
30	TOGGLE LINK W/ 3/8" DIA. PIN	48-030-01	1
-	OR TOGGLE LINK W/ 7/16" DIA. PIN	48-030-02	-
-	OR TOGGLE LINK W/ 1/2" DIA. PIN	48-030-03	-
31	HALF LENGTH FURL EXTRUSION	14-034-M03	1

System 1100 parts listing reflects new part numbers as of 2005. Please contact Schaefer Marine for furlers manufactured prior to this year.

*** Denotes new bearing race design (# 33-051-A). This new bearing design fits all 1100 and 1000 model jib furlers.

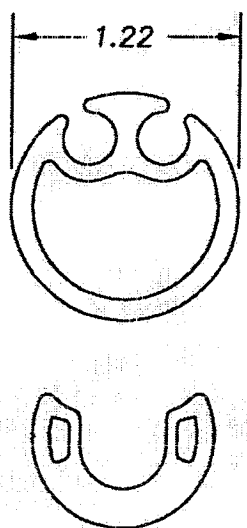

SYSTEM 2100 SCHEMATIC

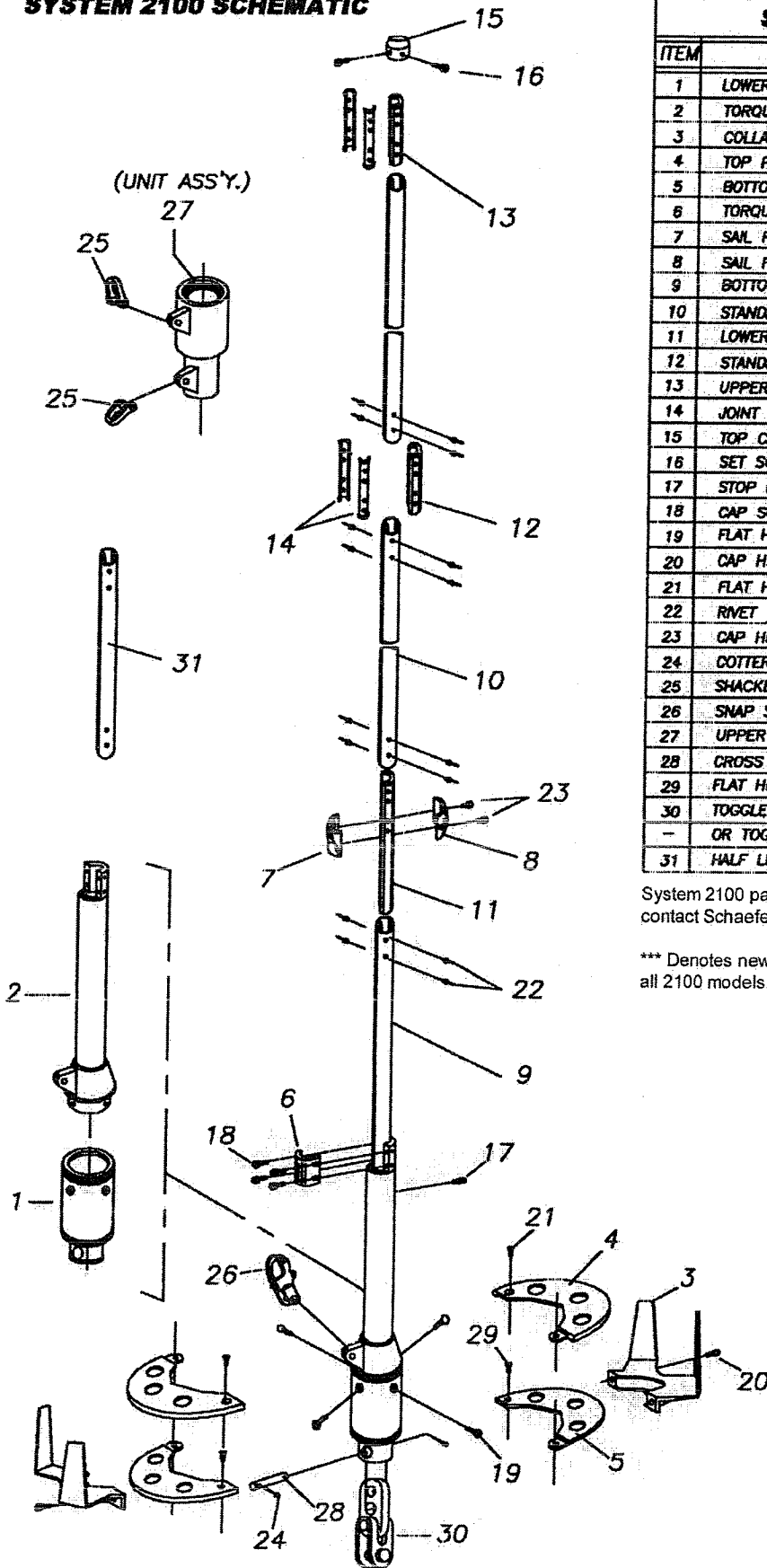

SYSTEM 2100 PARTS LIST

ITEM	DESCRIPTION	PART #	QTY.
1	LOWER BEARING ASSEMBLY***	33-049-A	1
2	TORQUE TUBE	33-039-A1	1
3	COLLAR BRACKET PLATE	45-236-A	2
4	TOP PLATE	35-322	2
5	BOTTOM PLATE	35-321	2
6	TORQUE TUBE CLAMP	32-024-01	1
7	SAIL FEEDER FRONT HALF	45-235-01	1
8	SAIL FEEDER BACK HALF	45-235-02	1
9	BOTTOM FURL EXTRUSION	14-054-01	1
10	STANDARD FURL EXTRUSION - 72" LONG	14-054-02	7
11	LOWER JOINT	14-061-01	1
12	STANDARD JOINT	14-061-02	7
13	UPPER JOINT	14-061-03	1
14	JOINT LINER	25-289	18
15	TOP CAP	32-023	1
16	SET SCREW	22-060	2
17	STOP PIN SCREW	24-045	1
18	CAP SCREW 10-24 X 5/8" LG.	24-057	4
19	FLAT HD. SCREW 1/4-20 X 5/8" LG.	22-313	4
20	CAP HD. SCREW 1/4-20	24-058	2
21	FLAT HD. SCREW 10-24	22-309	2
22	RIVET	30-087	70
23	CAP HD. SCREW 10-32	24-055	2
24	COTTER PIN	51-012-18	2
25	SHACKLE	93-11	2
26	SNAP SHACKLE	45-25	1
27	UPPER SWIVEL UNIT ASS'Y.***	33-054-A1	1
28	CROSS PIN	51-250	1
29	FLAT HD. SCREW 10-24 X 5/16" LG.	22-328	2
30	TOGGLE LINK W/ 1/2" DIA PIN	46-016	1
-	OR TOGGLE LINK W/ 5/8" PIN	46-018	-
31	HALF LENGTH FURL EXTRUSION	14-054-03	1

System 2100 parts listing reflects new part numbers as of July 2004. Please contact Schaefer Marine for furlers manufactured prior to this date.

*** Denotes new bearing design (# 33-049-A). This new bearing design fits all 2100 models. Call Schaefer for System 2000 jib furlers.

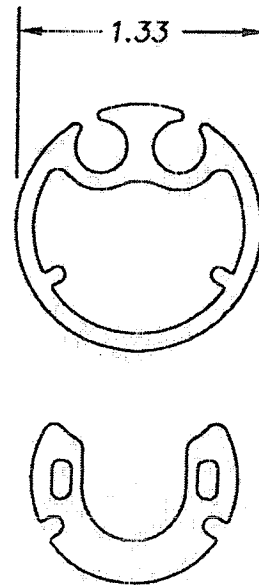

SYSTEM 3100 SCHEMATIC

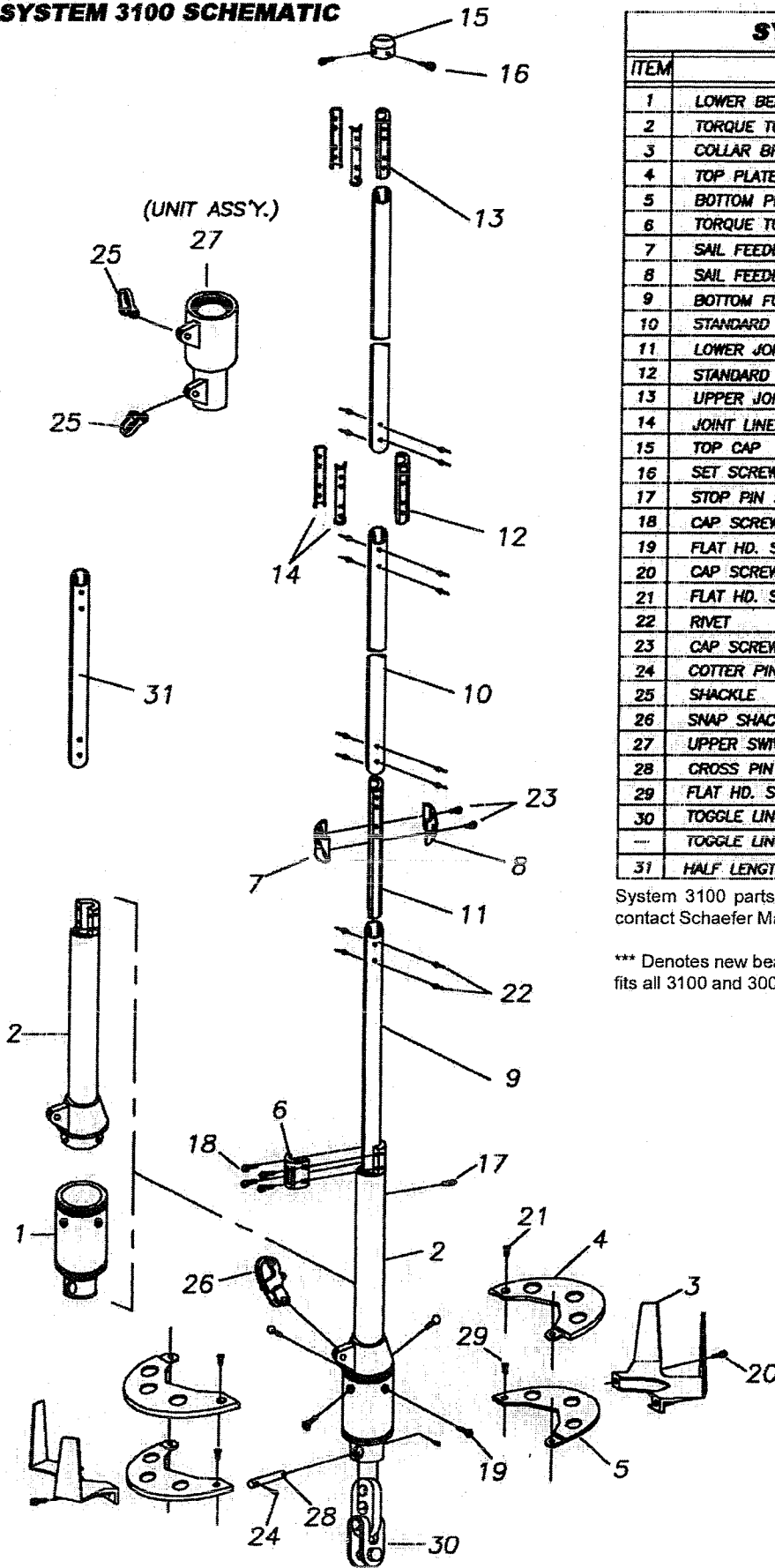

SYSTEM 3100 PARTS LIST

ITEM	DESCRIPTION	PART #	QTY.
1	LOWER BEARING ASSEMBLY***	33-053-A	1
2	TORQUE TUBE	33-027-A1	1
3	COLLAR BRACKET PLATE	45-228-A	2
4	TOP PLATE	35-328	2
5	BOTTOM PLATE	35-325	2
6	TORQUE TUBE CLAMP	32-016-01	1
7	SAIL FEEDER FRONT HALF	45-227-M01	1
8	SAIL FEEDER BACK HALF	45-227-M02	1
9	BOTTOM FURL EXTRUSION	14-057-01	1
10	STANDARD FURL EXTRUSION - 84" LONG	14-057-02	8
11	LOWER JOINT	14-067-01	1
12	STANDARD JOINT	14-067-02	8
13	UPPER JOINT	14-067-03	1
14	JOINT LINER	25-290	18
15	TOP CAP	32-015	1
16	SET SCREW	22-060	2
17	STOP PIN SCREW	24-043	1
18	CAP SCREW 1/4-20	24-058	4
19	FLAT HD. SCREW 1/4-20 X 5/8" LG.	22-313	5
20	CAP SCREW 1/4-20	24-058	2
21	FLAT HD. SCREW 10-24 X 3/8" LG.	22-309	2
22	RIVET	30-069	80
23	CAP SCREW	24-055	2
24	COTTER PIN	51-012-18	2
25	SHACKLE	93-14	2
26	SNAP SHACKLE	45-30	1
27	UPPER SWIVEL UNIT ASSY.***	33-052-A1	1
28	CROSS PIN	51-224	1
29	FLAT HD. SCREW 10-24 X 5/16" LG.	22-328	2
30	TOGGLE LINK W/ 5/8" DIA PIN	46-022	1
---	TOGGLE LINK W/ 3/4" DIA PIN	46-023	1
31	HALF LENGTH FURL EXTRUSION (42" LONG)	14-057-03	1

System 3100 parts listing reflects new part numbers as of 2005. Please contact Schaefer Marine for furlers manufactured prior to this year.

*** Denotes new bearing race design (# 33-053-A) This new bearing design fits all 3100 and 3000 model furlers.

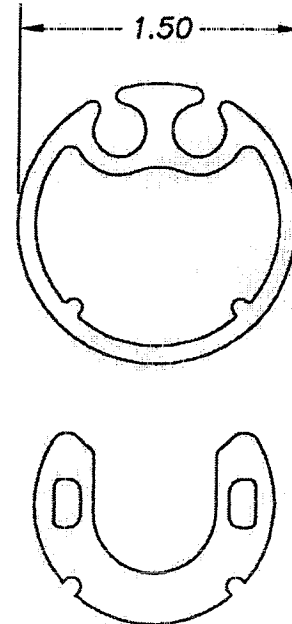

Sailmaker Instructions



WARNING

If you are in doubt about the assembly or sail conversion requirements for your boat, please seek the assistance of a professional rigger or sailmaker.

System 1100 for Boats 27' to 31' (8.2-9.5m)

System Length: 43' 0" (13m) provided system length

Sta-Lok™ Length: Wire/Pin 3/16"/ 3/8" (5/10mm) 7/32"/ 7/16" (5.5/12mm) 1/4"/ 1/2" (6/13mm) 9/32"/ 1/2" (7/13mm) Sta-Lok™ 2 1/8" (54mm) length 2 1/2" (64mm) length 2 9/16" (65mm) length 3" (76mm) length

Toggle/Link: Standard 4 1/8" (105mm) pin/pin Long 10 1/8" (257mm) pin/pin

Foils: (6) 6' (1.83m) round, twin groove for #6 (3/16", 5mm) luff tape
 Bearings: 3/8" (10mm) Torlon™ (38) dbl. race upper swivel, (38) dbl. race drum
 Drum Design: Open/split 3 1/8" (79mm) dia. drum uses 50' (15m), 1/4" (6mm) line
 Packaged Weight: 25 lbs. (12kg) furler, 36 lbs. (17kg) foils
 Rod Info: Foils pass up to a 1/2" (13mm) dia. nose, Joints accept -6, & -8 rod

System 2100 for Boats 30' to 42' (9.1-12.8m)

System Length: 49' 3" (15m) provided system length

Sta-Lok™ Length: Wire/Pin 1/4"/ 1/2" (6/13mm) 9/32"/ 1/2" (7/13mm) 5/16"/ 5/8" (8/16mm) 3/8"/ 5/8" (10/16mm) Sta-Lok™ 2 9/16" (65mm) length 3" (76mm) length 3 1/4" (83mm) length 3 3/4" (95mm) length

Toggle/Link: Standard 4 5/8" (118mm) pin/pin Long 12 1/8" (309mm) pin/pin

Foils: (7) 6' (1.83m) round, twin groove for #6 (3/16", 5mm) luff tape
 Bearings: 3/8" (10mm) Torlon™ (63) triple race upper swivel, (63) triple race drum
 Drum Design: Open/split 3 1/2" (89mm) dia. drum uses 70' (21m), 5/16" (8mm) line
 Packaged Weight: 28 lbs (13kg) furler, 38 lbs. (18kg) foils
 Rod Info: Foils pass up to a 5/8" (16mm) dia. nose, Joints accept -8, -10, -12, & -17 rod

System 3100 for Boats 41' to 55' (12.5-16.8m)

Length: 64' 7 1/2" (19.8m) provided system length

Sta-Lok™ Length: Wire/Pin 5/16"/ 5/8" (8/16mm) 3/8"/ 5/8" (10/16mm) 7/16"/ 3/4" (12/19mm) Sta-Lok™ 3 1/4" (83mm) length 3 3/4" (95mm) length 3 3/4" (95mm) length

Toggle/Link: Standard 6" (152mm) pin/pin Long 15" (382mm) pin/pin

Foils: (8) 7' (2.13m) round, twin groove for #6 (3/16", 5mm) luff tape
 Bearings: 3/8" (10mm) Torlon™ (75) triple race upper swivel, (75) triple race drum
 Drum Design: Open/split 4 3/8" (111mm) dia. drum uses 90' (27m), 3/8" (10mm) line
 Packaged Weight: 43 lbs. (20kg) furler, 67 lbs. (31kg) foils
 Rod Info: Foils pass up to a 3/4" (19mm) dia. nose, Joints accept -12, -17, & -22 rod

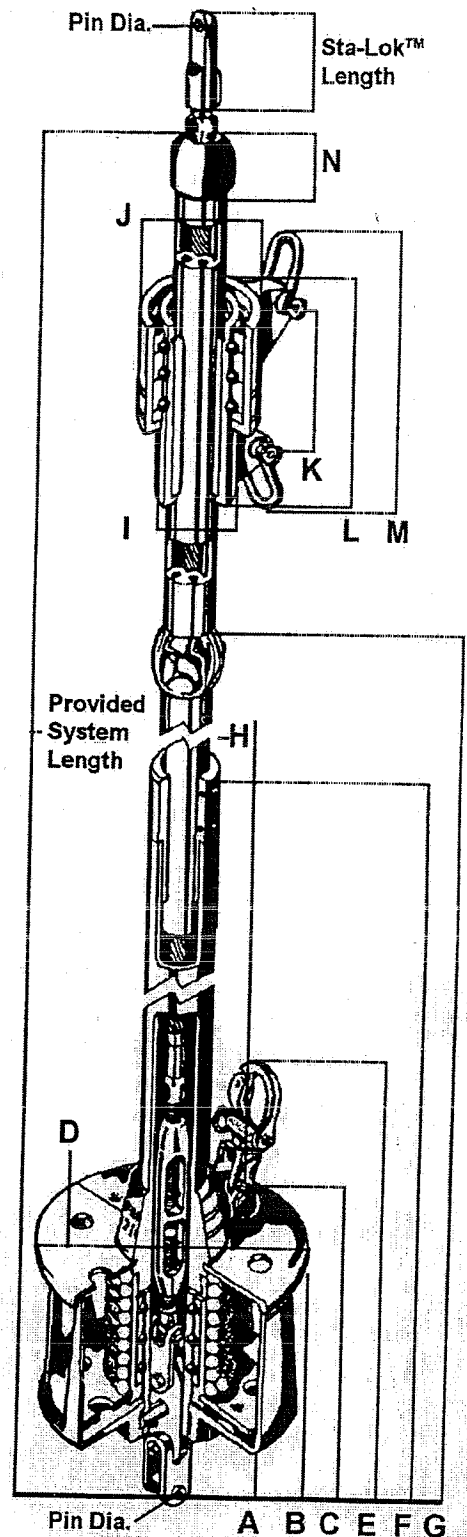

System	A	B	C	D	E	F	G	H	I	J	K	L	M	N
1100	3 1/4" (83mm)	7 1/2" (190mm)	8 11/16" (221mm)	6 3/4" (171mm)	11 1/8" (283mm)	27 1/8" (689mm)	47 1/2" (1.20m)	1 3/16" (30mm)	2" (51mm)	3 1/8" (79mm)	3 11/16" (94mm)	5 3/16" (132mm)	6" (153mm)	1 1/8" (29mm)
2100	3 3/4" (95mm)	8 5/8" (219mm)	10" (254mm)	8 1/4" (210mm)	13" (330mm)	29 5/8" (752mm)	50" (1.27m)	1 1/2" (38mm)	2 1/2" (64mm)	3 11/16" (94mm)	4 3/8" (111mm)	6 1/4" (159mm)	7 1/4" (184mm)	1 1/4" (32mm)
3100	4 3/4" (121mm)	10 1/8" (257mm)	11 13/16" (300mm)	11 1/8" (283mm)	15 7/8" (403mm)	41 1/4" (1.05m)	60 1/2" (1.54m)	1 1/2" (38mm)	2 1/2" (64mm)	4 3/8" (111mm)	4 3/8" (111mm)	6 5/8" (168mm)	7 3/4" (197mm)	2 7/16" (62mm)

New Headstay Cutting Instructions

The Schaefer System utilizes an additional, Integral Toggle/ Link which is installed between the turnbuckle and the sternhead pin effectively increasing the pin/pin length that must be factored into headstay construction or modification. Use the following deductions and calculation to determine the proper amount of wire to remove from your standard pin/pin measurement.



WARNING

New Headstay Cutting Instructions are for boats that wish to have a new headstay made with a pre-swaged eye fitting.

DO NOT cut the headstay of a Dealer/ OEM supplied furling system.

Go To Pg. 14 for Pre-Cut Installation Instructions for Dealer/ OEM installed systems which have been supplied with a pre-cut headstay length.

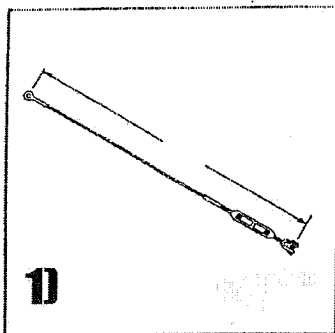

1) Lay the headstay out on the dock or work area. Inspect for wear, fraying or damage.

If you are unsure of the condition of your headstay, please seek the advice of a professional yacht fitter.

Measure your existing headstay length pin to pin for your records.

Be sure to note the turnbuckle position. (half open, open, closed)

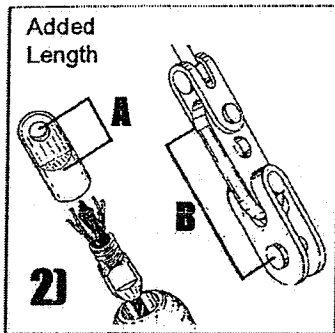

2) It is necessary to compensate for the additional length of the **STANDARD INTEGRAL TOGGLE/ LINK** and the eye portion of the Sta-Lok™ fitting that will be added to your headstay.

The combined length (toggle & Sta-Lok™) to be removed from your headstay for a standard Schaefer installation are as follows:

System	A + B
1100	5 3/8" (137mm)
2100	6 1/8" (155mm)
3100	7 5/8" (194mm)

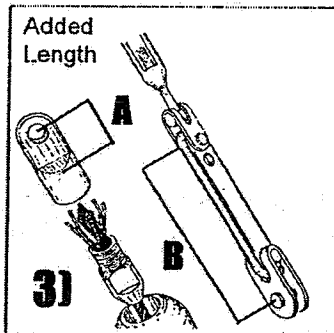

3) If Schaefer **LONG INTEGRAL TOGGLE/ LINKS** are used, remove the following total amount of wire:

The combined length (toggle & Sta-Lok™) to be removed from your headstay for a Long Schaefer installation are as follows:

System	A + B
1100	12 3/8" (314mm)
2100	13 5/8" (346mm)
3100	16 5/8" (422mm)

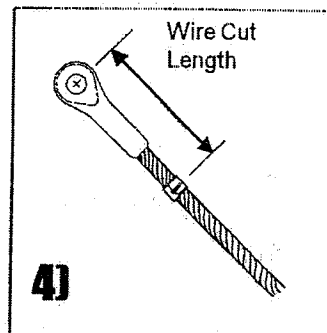

4) If you are adjusting a current stay, measure down the appropriate length from the center of the hole in the old wire fitting or swage stud at the top of the wire.

Wrap tape around the wire and make a mark with a pencil or pen. **Cut the wire at this mark.**



WARNING

If masthead or other toggles are added, an additional amount of wire should be removed!

Use the following deductions and calculation to determine the proper amount of wire to remove.

Use these deductions only if you have a custom application

Schaefer Integral Toggle Deductions (pin/pin)

System	Standard
1100	4 1/8" (105mm)
2100	4 5/8" (118mm)
3100	6" (152mm)

System	Long
1100	10 1/8" (257mm)
2100	12 1/8" (309mm)
3100	15" (382mm)

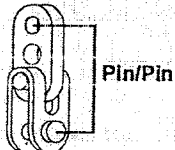

Schaefer Sta-Lok™ Deductions

Wire Size	Deduction
3/16" (5mm)	System 1100
7/32" (6mm)	1 1/4" (32mm)
1/4" (7mm)	
9/32" (8mm)	System 2100
9/32" (8mm)	1 1/2" (38mm)
5/16" (8mm)	
3/8" (11mm)	System 3100
3/8" (11mm)	1 3/4" (44mm)
7/16" (12mm)	

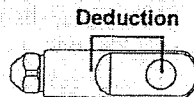

Custom Calculation

Schaefer Integral Toggle Link Deduction	<input type="text"/>
	+
Sta-Lok™ or Eye Deduction	<input type="text"/>
	+
Additional Toggle or Fitting Deduction	<input type="text"/>
Total Wire Cut Length	<input type="text"/>

Upper Foil Measurement And Cutting Instructions

Upper Foil Measurement Instructions are for boats that wish to have a new headstay made with a pre-swaged eye fitting. These calculations will allow you to determine the proper length of the upper foil.

If your system is dealer installed, it has been marked or pre-cut to allow installation over the headstay supplied with the boat.



WARNING

DO NOT cut the Foils of an Dealer/ OEM supplied furling system unless instructed to do so in a supplemental instruction sheet.

1) STAY LENGTH (SL)

SL =

Measure the stay length as shown from turnbuckle pin to end of swage fitting as shown.

Be sure turnbuckle is closed.

2) TORQUE TUBE (TT)

TT =

Enter the torque tube deduction from the table at the right.

3) TOP CAP (TC)

TC = 1 1/4" (32mm)

Enter the top cap deduction: (1 1/4" (32mm) for all models):

4) TOTAL LENGTH (TL)

TL =

Calculate the total length required above the feeder:

$$TL = SL - TT - TC$$

5) FULL FOILS (FF)

FF =

Enter the total number of full length foils less than the total length.

6) REMAINDER LENGTH (RL)

RL =

Calculate the remainder length.

If RL is greater than 18"

This is the TOP FOIL cut length.

If RL is less than 18"

Replace the TOP FULL LENGTH FOIL with a HALF LENGTH, and recalculate the RL (TOP FOIL cut length):

$$RL = TL - FF - HL$$

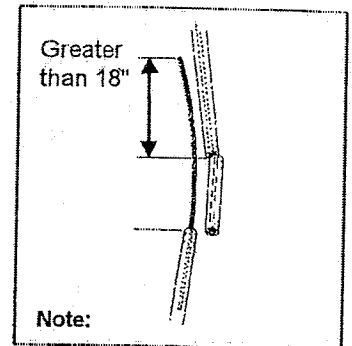
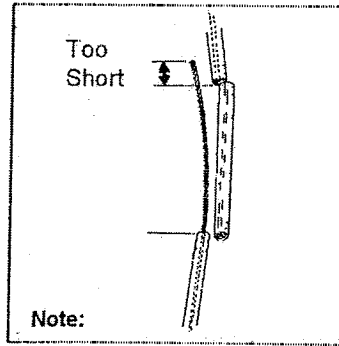

It is important that the top FOIL be at least 18" long when cut in order to accommodate both the length of the STANDARD JOINT and the TOP JOINT.

If needed, a pre-drilled HALF LENGTH FOIL has been provided to be used in place of the second from the top FULL LENGTH FOIL, thus making the TOP FOIL long enough to accept the TOP JOINT.

TORQUE TUBE (TT) deduction:

System 1100 = 3' - 8" (1120mm)
System 2100 = 3' - 10" (1170mm)
System 3100 = 4' - 7" (1400mm)

Number of FULL FOILS (FF) less than TOTAL LENGTH (TL):

System	FULL	1/2
1100	6'(1828mm)	3'(914mm)
2100	6'(1828mm)	3'(914mm)
3100	7'(2134mm)	3.5'(1067mm)

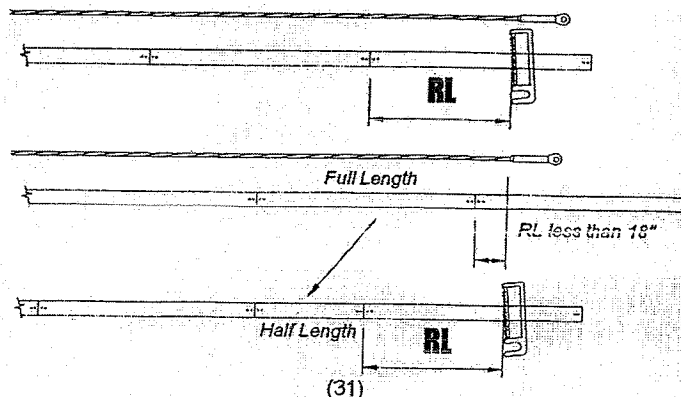
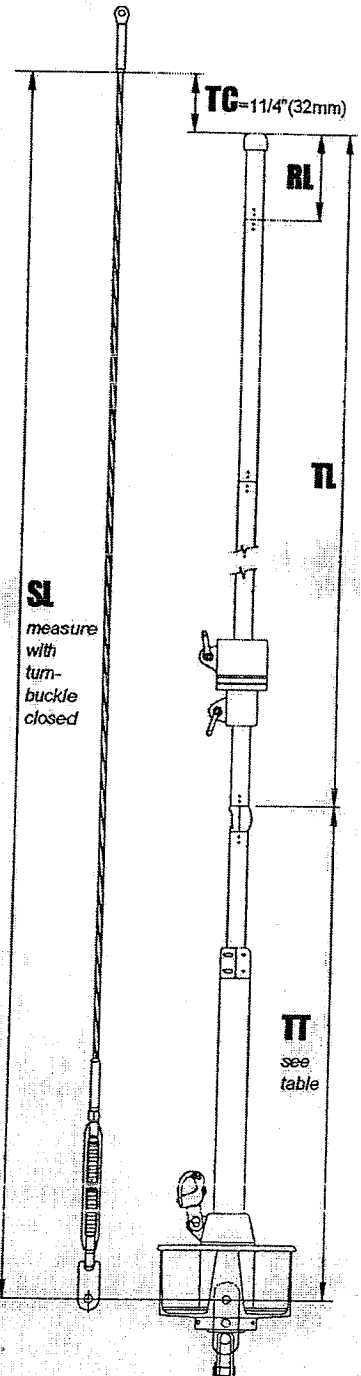

Warranty

Schaefer Marine, Inc. warrants its standard catalog products to be free from factory defects in material and workmanship for a period of five (5) years from the date of purchase, unless otherwise stated in this catalog or any other Schaefer Marine catalog.

At any time within five years of the demonstrated date of purchase, Schaefer Marine, Inc. will remedy any factory defect in material or workmanship (at no charge to the original purchaser) if the product is returned to Schaefer Marine, Inc. The buyer shall be responsible for shipping and insurance charges, if any, on the products returned for repair under the terms of this warranty. Schaefer Marine, Inc. will pay shipping for products returned to the buyer. Return of defective products must be accompanied by a letter giving name, address, proof of purchase, type of boat, and description of malfunction of the gear.

This warranty extends only to defects in material or workmanship of products in normal use. It does not extend to damage caused by accident or abuse, or to any consequential or incidental losses or damages arising from the products or their use. There are no other warranties, including that of merchantability, expressed or implied, other than those set forth herein which extend beyond the period of this warranty.

This warranty is in lieu of all other implied, express and statutory guarantees, and in no event shall Schaefer Marine, Inc. be liable for special, incidental or consequential damages.

Some states do not allow limitations on how long an implied warranty lasts, nor the exclusion or limitation of incidental or consequential damages, so the above limitations or exclusions may not apply to you. This warranty gives you specific legal rights, and you may also have other rights which vary from state to state.

SCHAEFER **LEGENDARY STRENGTH**

Remember, we are always here at Schaefer to help you - our customers.
Feel free to write, call, fax, or email us anytime with any questions or comments you may have.

Schaefer Marine, Inc. • 158 Duchaine Blvd. • New Bedford, MA 02745-1293
phone 508.995.9511 • fax 508.995.4882
www.schaefermarine.com • email: sales@schaefermarine.com